



Stainless Steel & Glass Hardware Collection

COMMERCIAL EDITION



Style Design Innovation

Established in 1995, Euro Architectural Components (**EAC**) a division of Richelieu Hardware Canada Ltd. - stands as a **LEADING RAILING SUPPLIER IN CANADA**, distinguished by our unwavering commitment to Style, Design, and Innovation. Catering to the Railing, Fence, and Glass industries, EAC delivers a comprehensive range of products marked by excellence at competitive prices.

With many years of experience in the architectural industry, EAC is driven by a desire to craft innovative products. Proudly designed in Ontario, our offerings prioritize product development, continuously pioneering innovative designs and enhancing the functionality of our extensive product lines, such as the exclusive Tilt-Lock™ range that continues to reinvent the industry. With a steadfast dedication to quality assurance, EAC ensures each product meets the highest standards of craftsmanship and durability, thanks to our in-house team of engineers.

Simplicity, quality, and timeless design are the key features that EAC's engineering team strives for during product development, utilizing the latest state-of-the-art CAD/CAE programs and advanced equipment such as 3D printers. Our goal is to meticulously develop and innovate every product, ensuring it meets or exceeds standard strength requirements while carefully considering aesthetics and ease of installation. EAC's in-house testing and certification procedures ensure new products comply with national and provincial building codes at every stage of development.

EAC proudly provides comprehensive technical and engineering documentation, including BIM files, Auto CAD blocks, and CSI 3-part specifications, for all our commercial-grade systems. You can conveniently access these resources either directly through our website euroeac.com or via BIMOBJECTS, ensuring effortless accessibility.

For technical questions, details about custom product development, or inquiries about sourcing your exclusive design, please contact

engineering@euroeac.com

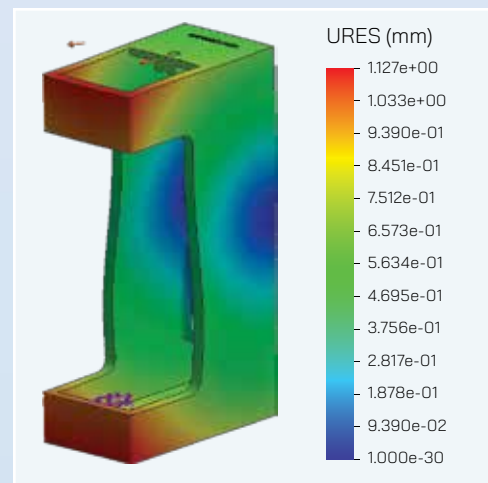
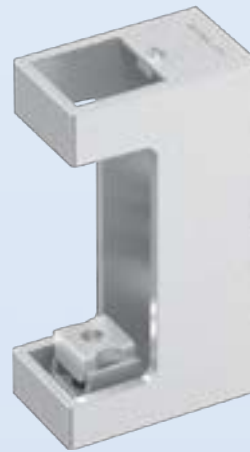

3D Revit, CAD, and Technical Files NOW AVAILABLE ON **bimobject**[®]

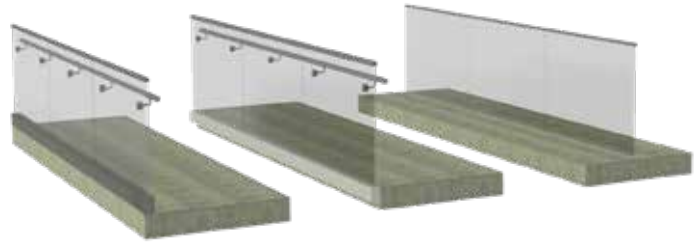
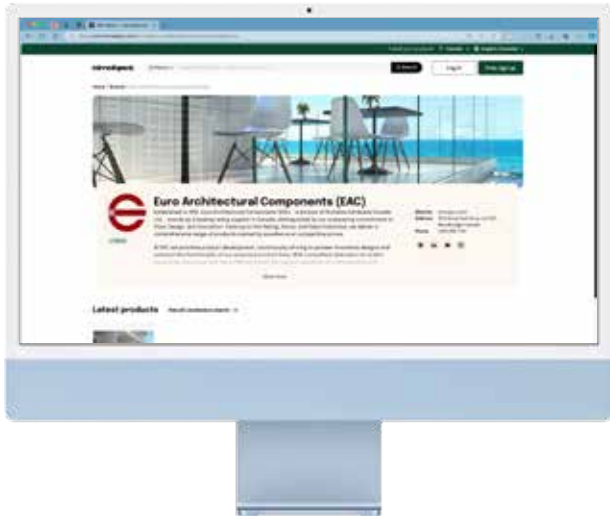

Effortlessly access comprehensive system specifications, saving valuable time in selecting the right products for your project.

Certified Laminate Glass with PVB & SentryGlas[®]

EAC offers certified laminate glass with PVB and SentryGlas[®] interlayers, ideal for railing and glazing applications. Engineered for strength, clarity, and safety, our glass is a reliable choice for architectural projects.

Inquire engineering@euroeac.com.



Custom Architectural Products Development Services

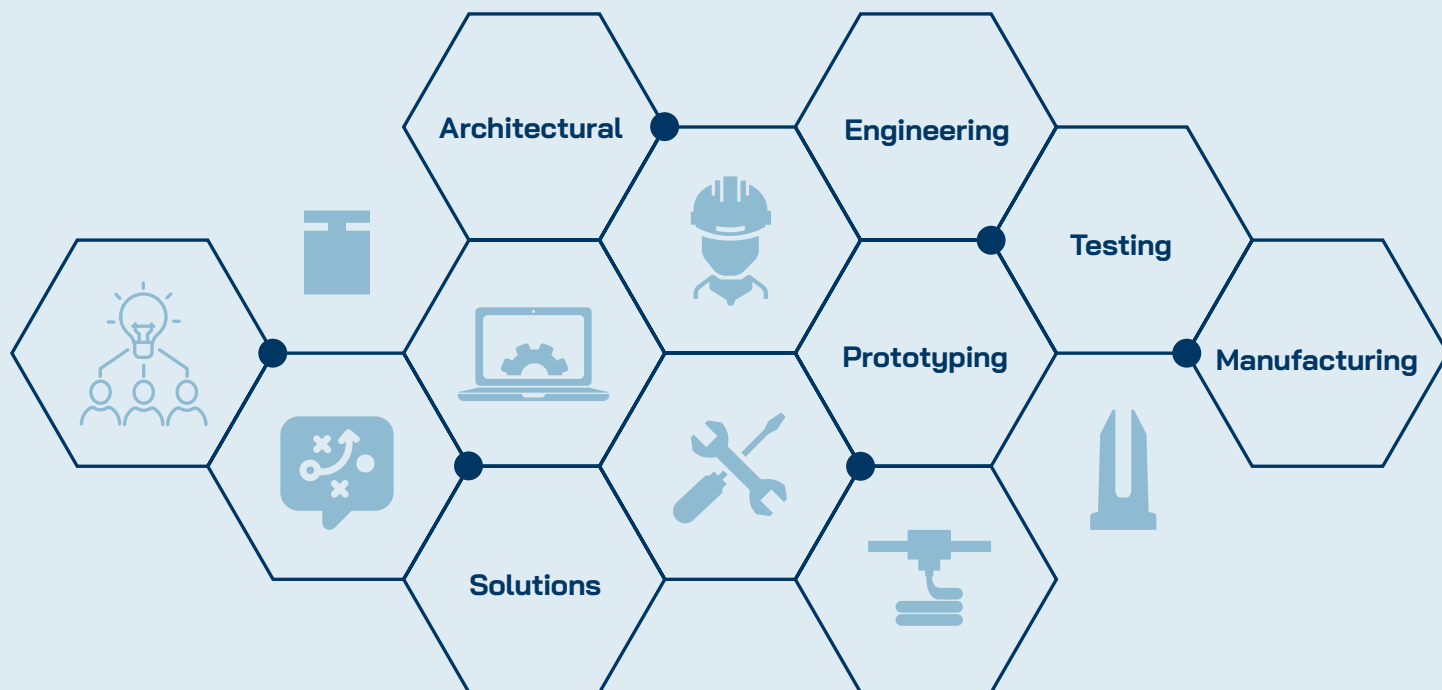

Bring your ideas to life

Our team of highly skilled engineers at Euro Architectural Components is ready to collaborate with you to turn your designs into reality. EAC provides product development services for exclusive custom architectural products, guiding you from ideation through to final testing, certification, and manufacturing.

With more than 25 years in the architectural components industry, EAC has developed the experience and expertise to confidently guide you through every step of the process.

Bring your ideas to life today by contacting us at engineering@euroeac.com.

EAC T3 Adjustable Standoff with exclusive TILT-LOCK™ Technology
is an example of one of our custom-designed engineered products.

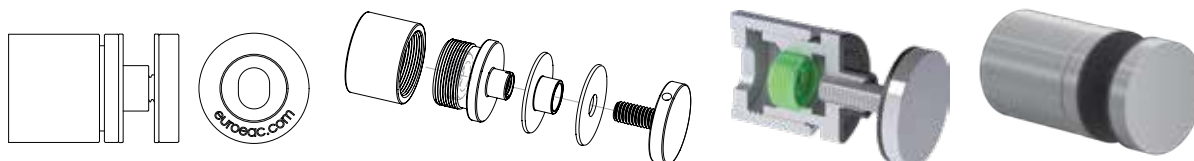

Scan to view all of our custom-designed products



Base Shoes

2



Posts

8



Standoffs

12



Glass Canopy

18



Glass Railing Tops

22



Handrail Profiles & Brackets

26



Glass Wall & Door Hardware

32



Base Shoes



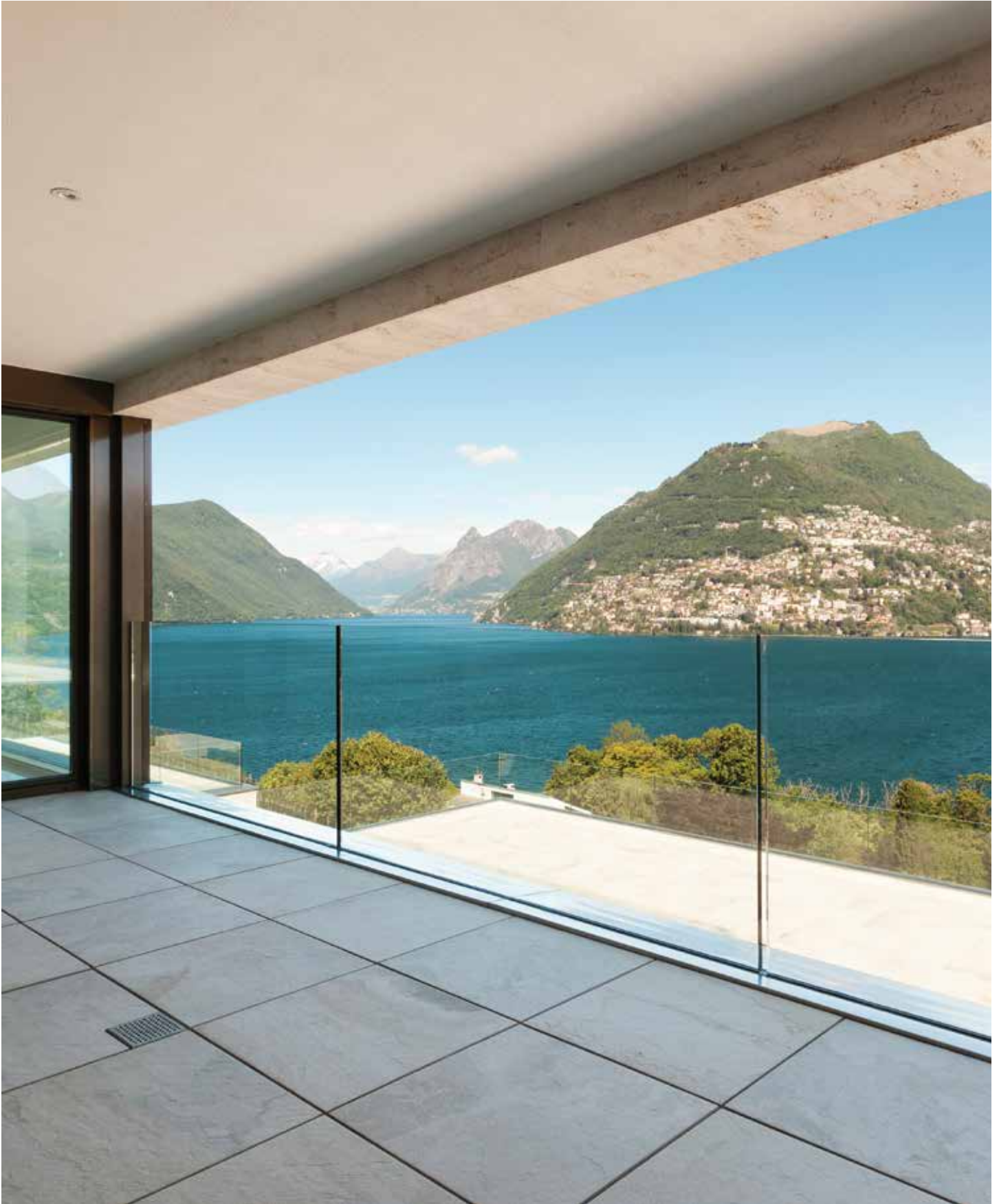



Ready-to-Install EAC Adjustable Base Shoes with exclusive Tilt-Lock™ Technology are available in 6 models: M2, M3, M4, M5, M6L, and M6Y, accommodating glass sizes from 12-26.52mm.



TILT-LOCK™ Technology allows for a 2° front and back tilt of the glass within the shoe, giving you faster and easier installation with exact alignment every time. This is all achievable from one side, making your projects more efficient.

EAC Adjustable Base Shoes with TILT-LOCK™ Technology are ready-to-install with pre-drilled holes and fully concealed components, offering a clean, finished, and perfectly aligned look. Additional accessories are available.

Specifications

Base Shoe Material: Alkaline Anodized Aluminum 6063-T6.

Aluminum Cladding: Satin Anodized Aluminum 6463-T5 with attached Gaskets and matching end caps.

Stainless Steel Cladding: Stainless Steel 316L in Satin finish and small Aluminum Clip-on Channel with attached Gaskets and matching End Caps.

Features



Engineered for the National Building Code of Canada.



Patented in Canada, the U.S., The U.K., Europe, Australia, New Zealand, and China.

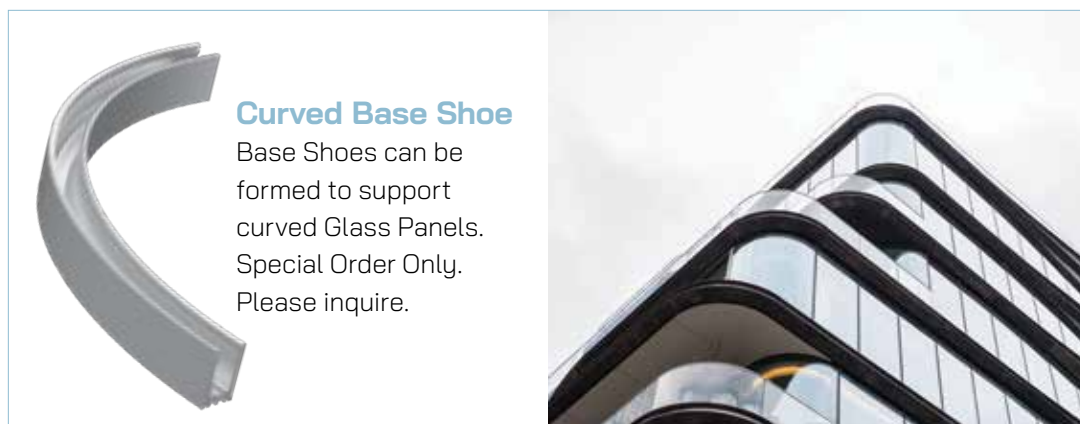
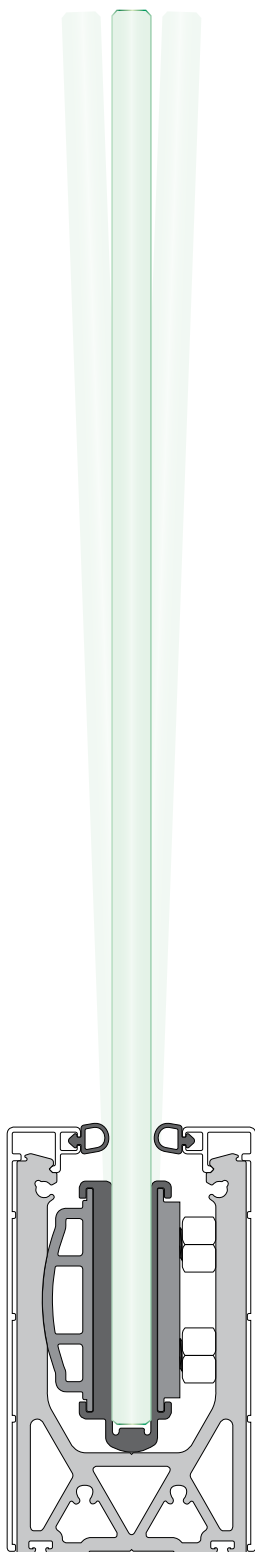

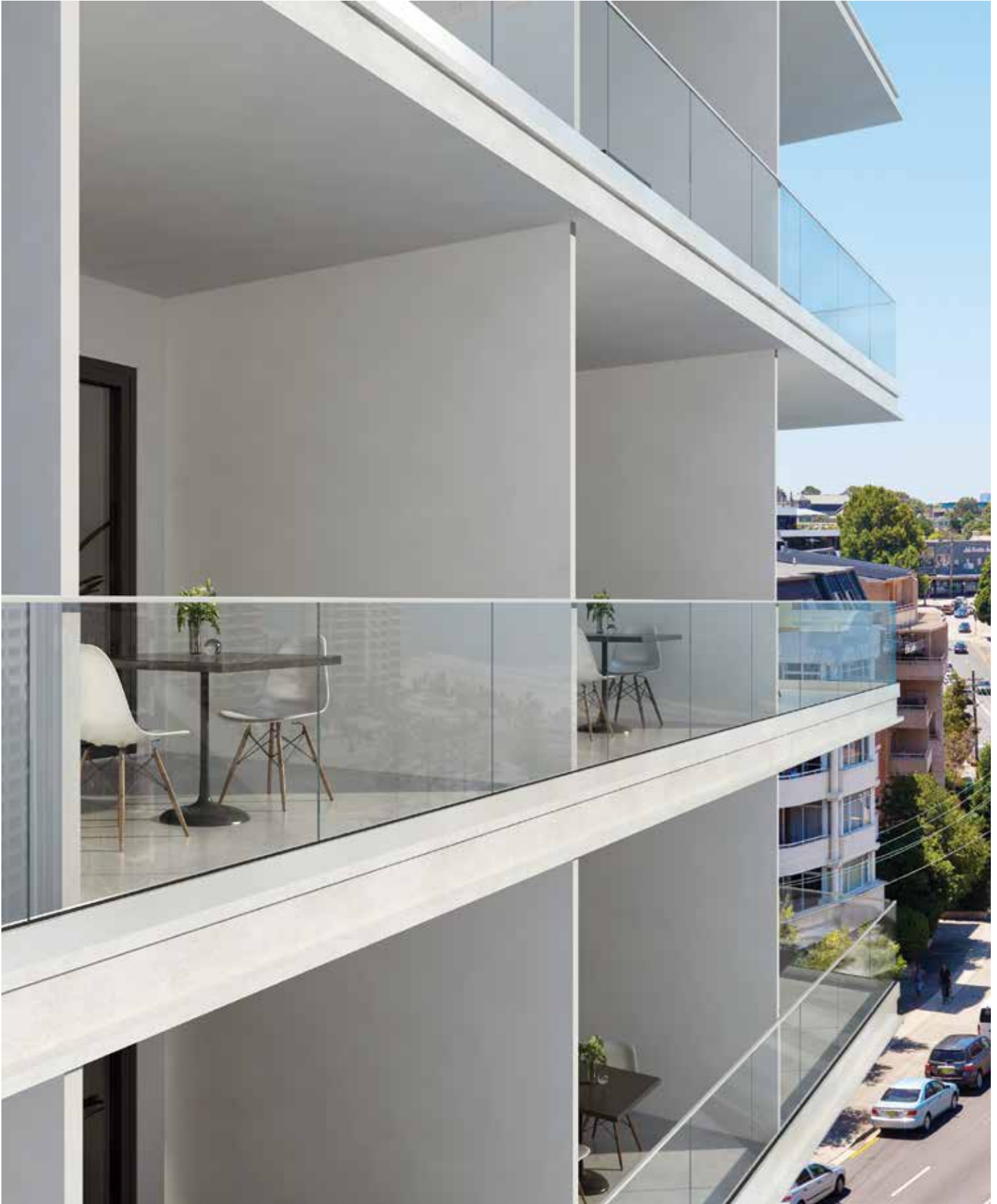

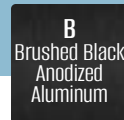
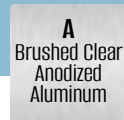

M2

Glass Thickness 12-12.76mm



See More Info



- Low Profile
- Top Mount
- Recessed
- 10ft length (custom sizes available)
- 1 pre-drilled hole every 12"

M3

Glass Thickness 12-12.76mm



See More Info



- Top Mount
- Side Mount
- Recessed
- 10 & 20 ft lengths (custom sizes available)
- 1 pre-drilled hole every 12"

M4

Glass Thickness 12-17.52mm



See More Info



- Top Mount
- Side Mount
- Recessed
- 10ft length (custom sizes available)
- 1 pre-drilled hole every 6"

M5

Glass Thickness 19-26.52mm



See More Info



- Top Mount
- Side Mount
- Recessed
- 10ft length (custom sizes available)
- 1 pre-drilled hole every 6"

M6Y

Glass Thickness 19-26.52mm



See More Info



- Side Mount
- 10ft length (custom sizes available)
- 1 pre-drilled hole every 6"

M6L

Glass Thickness 19-26.52mm



See More Info



- Top Mount
- 10ft length (custom sizes available)
- 1 pre-drilled hole every 6"



A photograph of a modern building with a glass facade. In the foreground, there is a balcony with a glass railing supported by metal posts. The floor is made of large, light-colored tiles. The background shows a large building with many windows and some greenery. The image has a blue tint.

Posts

Engineered for both interior and exterior applications,
designed to withstand high loads and heavy traffic environments.

P1 SERIES - Rectangular 25x50mm



Double
Arm Glass
Connectors



Straight Posts
Spiders



Glass
Clips



P2 SERIES - Square 50x50mm



Double
Arm Glass
Connectors



Straight Posts
Spiders



Glass
Clips



P3 SERIES - Round Ø50mm



Double Arm
Glass
Connectors



Straight Posts
Spiders



Glass
Clips





Landing Posts with Welded Bases

Designed for end, line, and corner post configurations.

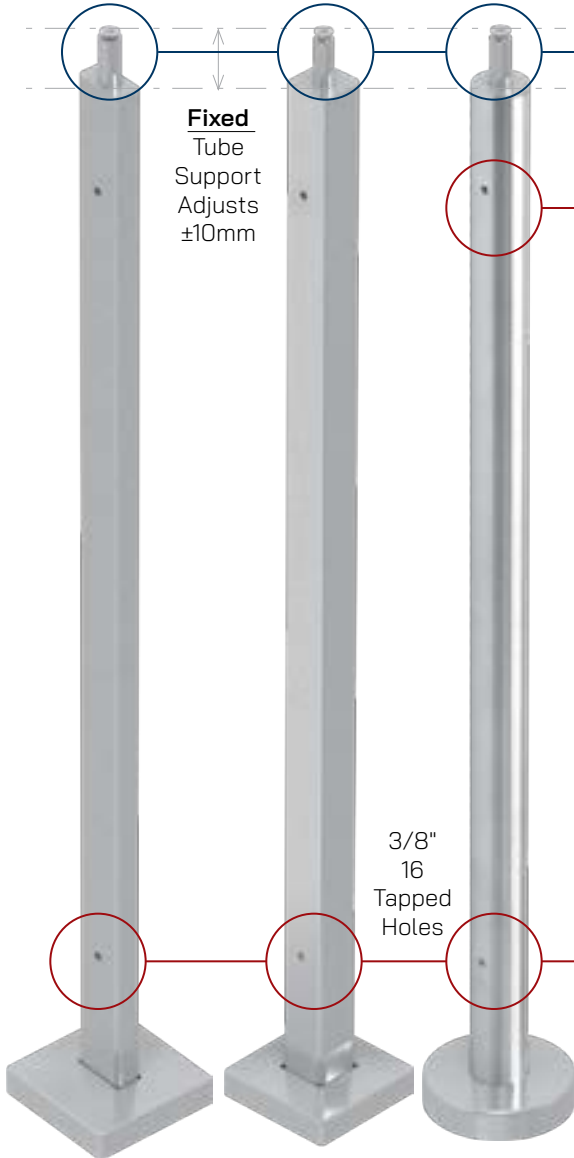

Fixed
Tube
Support
Adjusts
±10mm

3/8"
16
Tapped
Holes

Complete with Base Plate and Base Plate Cover

Handrail Attachment Plates

Flat and Curved Handrail Attachment Plates Available.

Optional End Cap Available.

Options to Secure Glass Panels

Option A
Fixed/Swivel Double-Arm Glass Connectors

Option B
Single/Double Post Spiders

Option C
Glass Clips

Options to Secure Blank Posts

Can be core mounted or secured with the options below.

Stanchion with Epoxy

Welded Base Plate with Plate Cover & Levelling Plate

Leveling Plates

Blank Posts

Designed for stair and core mount installations.

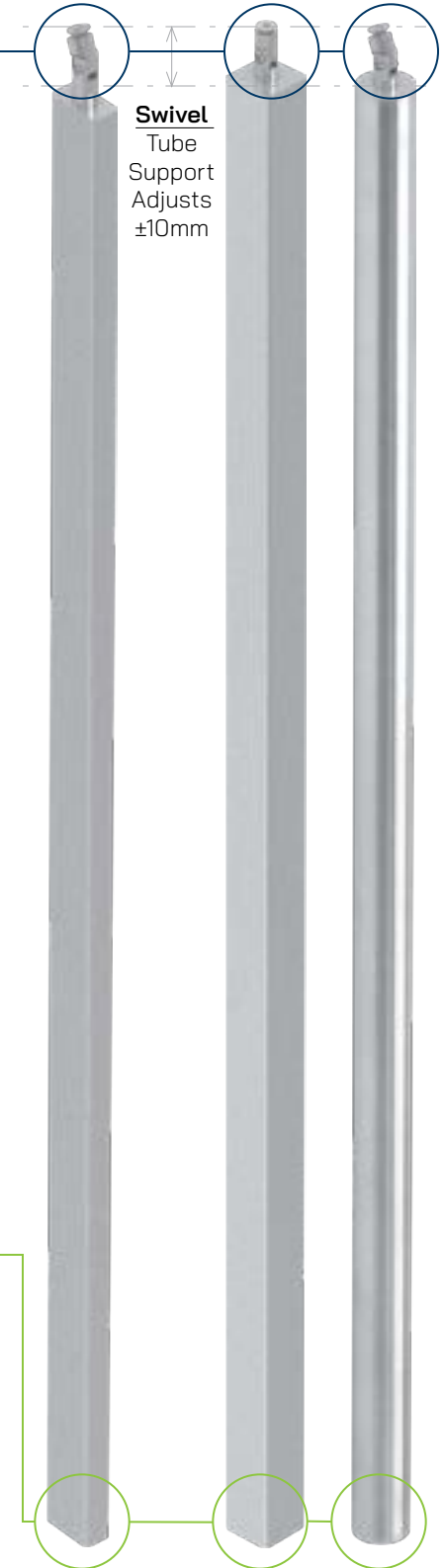

Swivel
Tube
Support
Adjusts
±10mm





Standoffs



EAC Adjustable/Lockable Glass Standoffs with TILT-LOCK™ Technology

EAC Adjustable Glass Standoffs with exclusive **TILT-LOCK™ Technology** allow easy and precise vertical alignment of glass panels. After the glass panel is set in place, it can be vertically aligned from the front using the **EAC Adjustable Standoff Tool** by tightening or loosening the telescoping portion of the standoff.

EAC Adjustable Glass Standoffs with exclusive **TILT-LOCK™ Technology** are available in 1 1/2" and 2" diameters in various lengths. All sizes are available in **Satin (S)**, with some sizes also available in **Powder Coated Satin Black (B)**, **PVD Brushed Graphite Black (GB)**, and **PVD Brushed Gold (G)** finishes. These standoffs feature an internal locking mechanism with a clean design that conceals the threads in the spacer.

- **NEW** increased range of glass sizes from 3/8" - 7/8", suitable for commercial and residential projects.
- **Locking system** secures standoff in adjusted position, preventing misalignment once the cap is assembled or disassembled.
- **Adjustability** enables a tilt range of +/-3° for glass railings, while our T3 slotted model's slot hole offers both vertical and horizontal adjustment, allowing for complete 3D adjustability.
- **Duplex 2205** Ultra Marine Grade Stainless Steel, solid material.
- **Designed by EAC.** Proudly designed in Ontario and fully engineered for the National Building Code of Canada.
- Cap and threaded rod come as one cast piece for superior strength.
- **Patented in Canada (313 8408) and the U.S. (118 41043).**

Standard Glass Standoffs

EAC's popular **Standard** Glass Standoffs are made of high-quality 316 and 304 Grade Stainless Steel and are available in Round or Square to suit your design needs.

- Includes imperial thread and is available in 3 finishes: **Satin**, **PVD Brushed Graphite Black**, and **SS304 Powder Coated Satin Black**.
- The spacer design has a short lip to provide a smooth surface for the glass to be held in place for installation.
- Imperial fastening options are available. For threaded rods and hanger bolts, use the same thread size as the spacer.





Adjustable Standoff Tool

SSJT1 - Required for T3 Slotted Standoffs

Designed by **EAC**, this tool facilitates the adjustment of **EAC Adjustable Glass Standoffs**. The two rounded ends are specifically made for adjusting **1 1/2"** and **2"** diameters, respectively. The Allen key is used to lock and secure the standoffs in place. Sold separately.



3D Adjustability (T3 models only)

1. Adjust horizontally, side to side, and vertically, up and down.

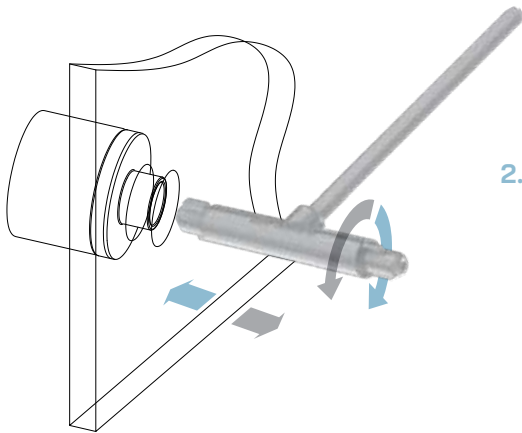

2. Adjust forward or backward for a $\pm 3^\circ$ tilt.

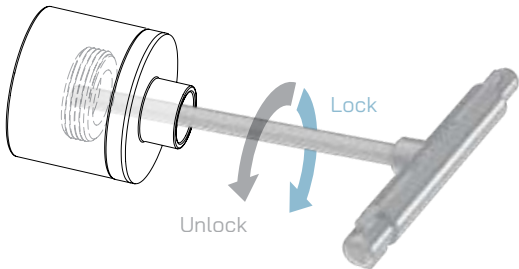

3. Lock into place. This tool can also be used to lock our T3T Tapped model.

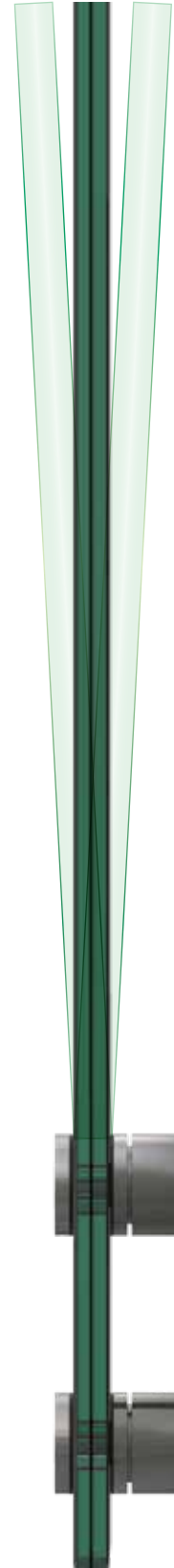

More standoffs online



T3 installation video

Please direct questions to
engineering@euroeac.com



T3T-LOCK™
Adjustable Railing Technology

T3T Lockable Tapped Round



Size Available
1 1/2" Diameter

EAC T3T Lockable Tapped Round Standoffs are the fastest and easiest to install. They use a tapped fastening method for quick installation and come in a variety of finishes to match our T3 Standoff line.



T3 Lockable Slotted Round



Sizes Available
1 1/2" Diameter
2" Diameter

EAC T3 Lockable Slotted Round Standoffs are highly versatile, featuring 3D adjustability. This allows you to adjust the glass panel horizontally, vertically, and $\pm 3^\circ$ forward/backward. This flexibility ensures precise alignment and a flawless installation of frameless glass railings, making it easier to achieve perfect results on-site.



T3 Lockable Slotted Square



Size Available
1 1/2" x 1 1/2"

EAC T3 Lockable Slotted Square Standoffs include all of the same features as our Round T3 Slotted model, packaged in a beautiful square design.





Standard Round Standoffs



Sizes Available
1 1/4" Diameter
1 1/2" Diameter
2" Diameter



EAC Standard Standoffs are non-adjustable and serve as our most basic option. Despite their simplicity, they are constructed to EAC's rigorous standards, ensuring exceptional durability and long-lasting performance.

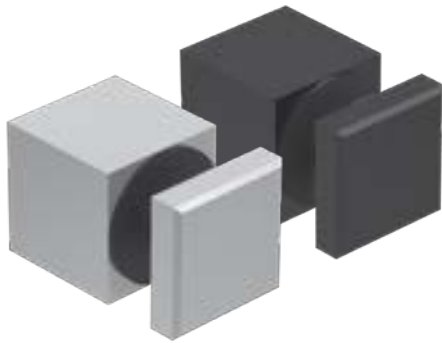

Standard Square Standoffs



Sizes Available
1 1/2" x 1 1/2"



Photo: Alumina



A photograph of a modern building's exterior featuring a glass canopy system. The canopy consists of multiple horizontal metal beams supported by vertical posts, with glass panels attached to the beams. The building has large glass windows and a tiled walkway. The image is overlaid with a semi-transparent dark blue band containing the text.

Glass Canopy System



EAC Heavy-Duty Spider Fittings are attached to a structure to secure glass panels to form a glass canopy or awning system, a glass post railing system, and a structural glass facade or glass wall partition.

Spider fittings are made by solid cast stainless steel, engineered for interior and exterior applications.

Heavy-Duty Spiders

- Available configurations: 1-arm, 2-arm, 3-arm, and 4-arm.
- M16x2.0 tapped holes for fastening to the structure.
- Provides an overall offset of 70mm [2 3/4"].
- Material: Duplex 2205 stainless steel in satin finish.



Heavy-Duty Glass Connectors

- Available connector types: Fixed connector and swivel connector.
- Mounting types: Cap mount and flush mount.
- Material: Stainless steel 316 in satin finish.
- M14 connector size.



Heavy-Duty Spider with Glass Connector Assembled Dimensions

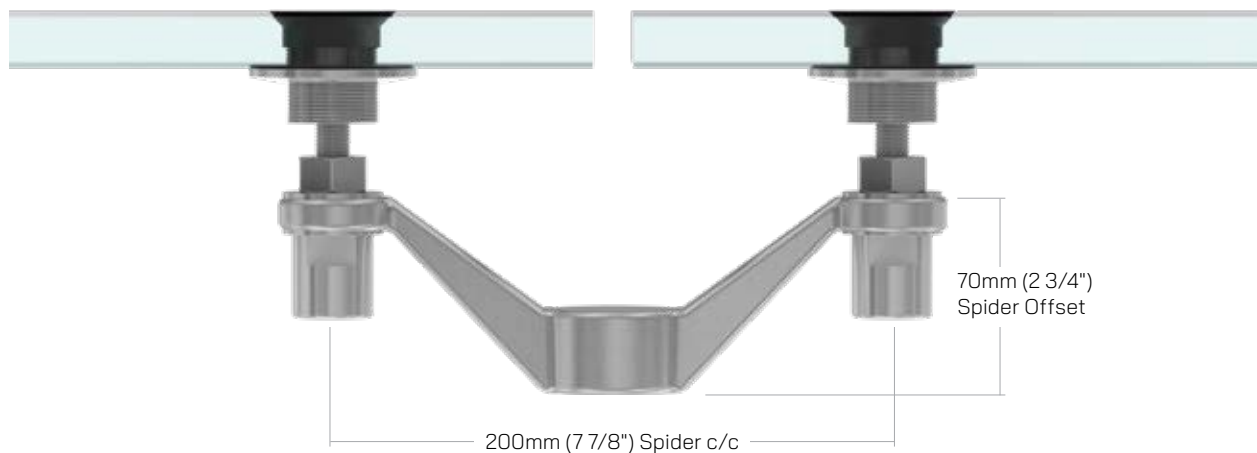



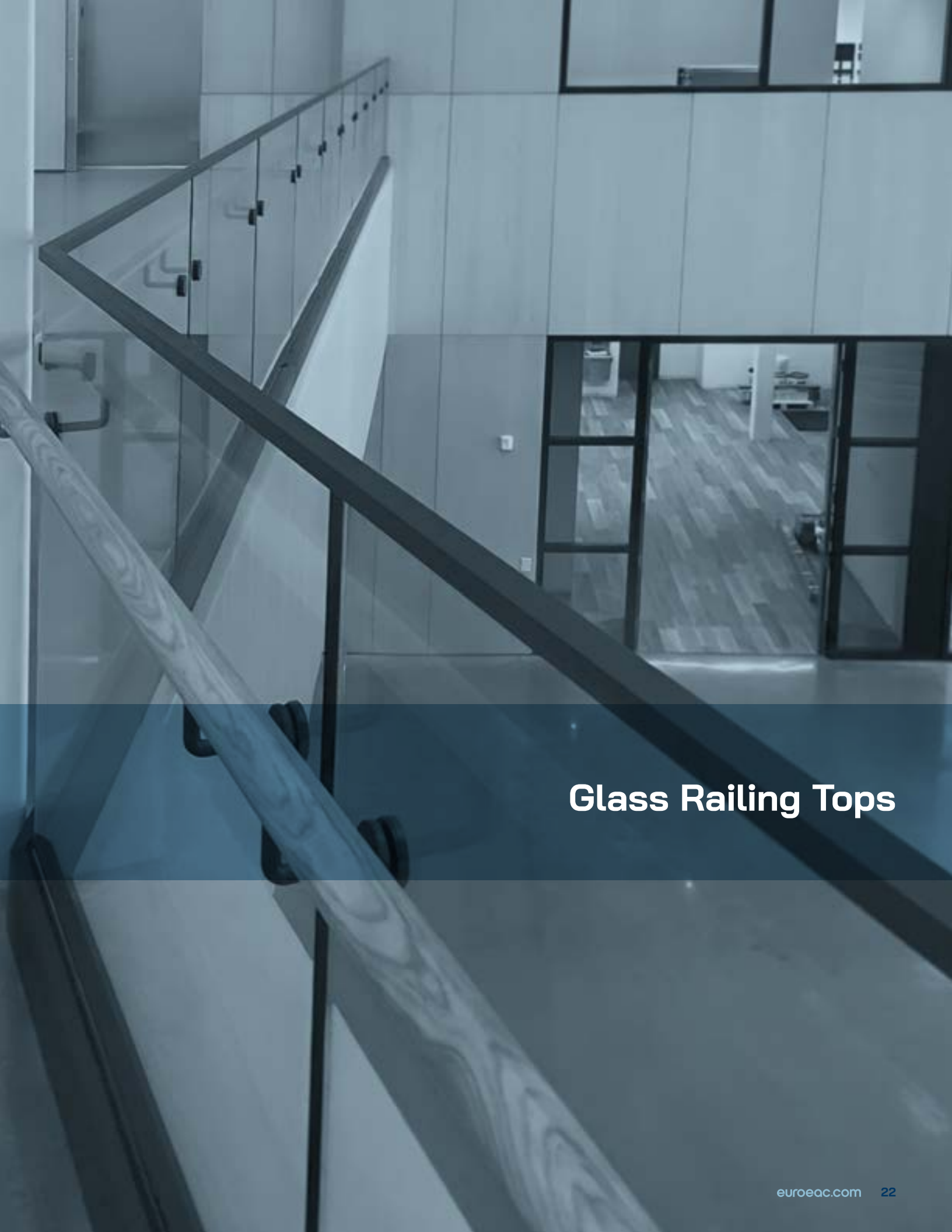

Glass Railing Tops

EAC Glass Top Rails are the perfect finishing touch for your glass railings. Designed with both aesthetics and functionality in mind, these sleek rails not only enhance the visual appeal of your glass railings but also provide added durability and strength. Crafted to perfection, EAC Glass Top Rails feature a smooth surface that offers a comfortable grip for any hand.

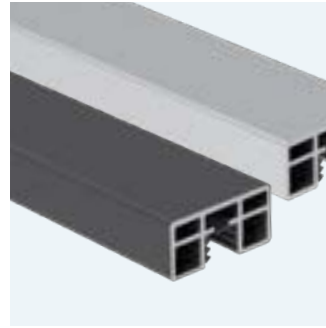
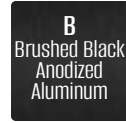

Photo: Fort Rouge Glass



Aluminum Cap Rails

- Brushed Anodized Aluminum 6063.
- Standard 19' lengths.
- Gaskets and full range of Fittings available.
- **NO WELDING REQUIRED** using our recommended SSRK-1500 Adhesive.



Stainless Steel Cap Rails

- Cap Rails & Fittings are a high Grade Stainless Steel.
- Standard 19' lengths.
- Gaskets and full range of Fittings available.



Top Channels & Fittings

- Stainless Steel 316L Grade.
- **NO WELDING REQUIRED** using our recommended SSRK-1500 Adhesive.
- Gaskets and full range of Fittings available.







Handrail Profiles & Brackets



Tubes & Bars

All **EAC handrail profiles**, including our tubes and bars, are expertly finished to ensure a premium feel. Available in different sizes at **19'** lengths, you can be sure to find the perfect style for your handrail feature. EAC tubes and bars are crafted for durability and strength, featuring a smooth surface with no sharp edges for a comfortable grip



Tubes

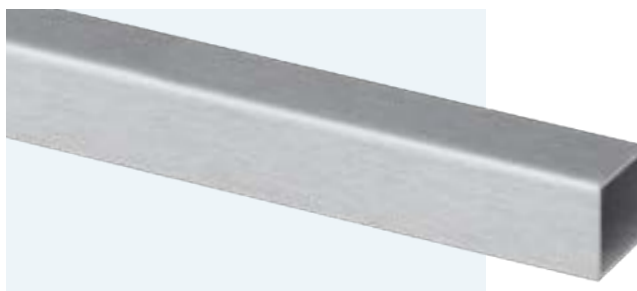
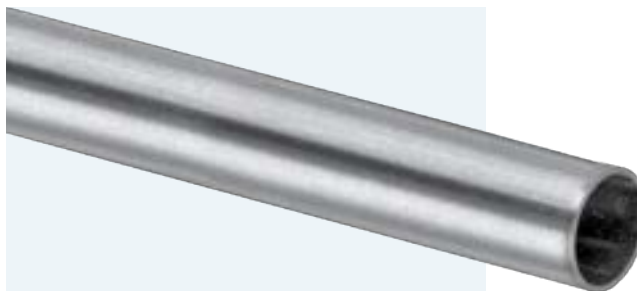

Rods / Bars





Round

RD2 Series - Standard Concealed

Off-the-Wall model that features a cover to conceal the fasteners.



S Satin Stainless Steel	B Powder Coated Satin Black	GB PVD Brushed Graphite Black	
---	---	---	--

RD3 Series - Standard Welded

Off-the-Wall & Off-the-Glass models feature a standard welded fastening method.



S Satin Stainless Steel	
---	--

RD4 Series - Height Adjustable

EAC versatile RD4 handrail brackets: Off-the-Wall, Off-the-Glass, Off-the-Post, and swivel models—all featuring height adjustability to ensure your handrail is perfectly level and at your desired height. The Off-the-Post model is designed to accommodate both round and square posts, thanks to its innovative round post adaptors.

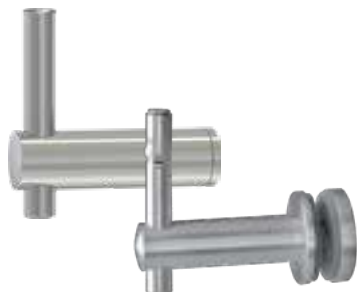

S Satin Stainless Steel	B Powder Coated Satin Black	
---	---	--



RD5 Series - Heavy-Duty

EAC's strongest, toughest round handrail bracket, available in Off-the-Wall & Off-the-Glass models.

S Satin Stainless Steel	B Powder Coated Satin Black	
---	---	--

RD6 Series - Heavy-Duty / Length Adjustable

A super-durable handrail bracket, available in both Off-the-Glass and Off-the-Wall models. Each design features length adjustability, providing unparalleled versatility on-site to ensure a flawless finished appearance every time.



S Satin Stainless Steel	B Powder Coated Satin Black	GB PVD Brushed Graphite Black	
---	---	---	--

Square



SQ2 Series - Standard Concealed

The SQ2 Series Concealed Bracket has a patented snap-on cover that hides fasteners while allowing easy access. Available in Off-the-Wall and Off-the-Glass models.



SQ4 Series - Height Adjustable

SQ4 Height Adjustable Brackets offer versatile, easy installation with on-site height adjustability and swivel saddles. Available in Off-the-Wall and Off-the-Glass models.



SQ5 Series - Heavy Duty

EAC's strongest, toughest square handrail bracket, available in Off-the-Wall & Off-the-Glass models.







Glass Wall & Door Hardware



Glass Wall Channel Kits

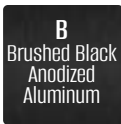

EAC Glass Channel Kit creates a safe and clean, modern finish to your Glass Walls or Partitions.

- Packed as a 12 ft. Kit, including top and Bottom Channels, End Caps, and Gaskets.
- Designed for Top and Side Mount applications.
- Easy installation with removable Cover.
- Full-frame Glazing (4 sides) possible.
- Engineered based on the Building Code sec. 4.1.5.14 "Loads on Guards". and 4.1.5.16 "Loads on Walls Acting as Guards", and CAN/CGSB 12.20-M89.



Standard Channels

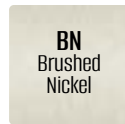
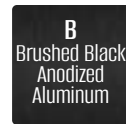
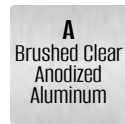

EAC Standard Glass Channels are an excellent choice for any type of interior glass wall. They offer a modern design and are available in a wide range of various sizes and finishes.



11/16" x 3/4"



1" x 1"



1" x 1 1/2"



1" x 2"



3/4" x 1/8"



Door Hardware

EAC provides a comprehensive range of high-quality door hardware solutions specifically engineered to elevate both the aesthetics and functionality of your pivoting doors. **EAC** Offerings include locking and non-locking ladder pull handles, magnetic locks, pull handles, electronic locks, and more, ensuring a versatile selection to meet diverse needs and preferences.

Handles



Electronic Locks



Magnetic Locks



Centre Locks



Patch Fittings



Patch fittings deliver a pristine, all-glass door appearance, seamlessly integrating with our glass wall channels and kits. Their elegant, minimalist design is matched by a robust construction that ensures the secure and reliable installation of glass.

- Standard & Hydraulic options available.
- With or without floor lock
- 7 Models available





DISCLAIMER: Euro Architectural Components carefully reviewed the content to ensure it was accurate at the time of print. We are not responsible for misinformation due to human error. Images or colours may not be exact due to rendering, photographic, or printing procedures. Consult your local authorities to ensure your design complies with all building code requirements. For our complete terms & conditions, scan here, or copy the following link: <https://euroeac.com/terms-conditions/>.



Version 2 • March 2025

 **euro** ARCHITECTURAL COMPONENTS
Since 1995 • A Division of Richelieu Hardware Ltd.

TORONTO
MONTREAL
CALGARY

127A Aviva Park Drive, Vaughan, Ontario
9015 rue Champ d'Eau, Montréal, Québec
220-10 Stonehill Place NE, Calgary, Alberta

L4L 9C1 • T 905.265.1093 • TF 800.465.7143
H1P 3M3 • T 514.325.7977 • SF 866.574.7979
T3N 1T7 • T 905.265.1093 • TF 800.465.7143

euroeac.com

