

Shower
Hardware
Collection
VOLUME 1

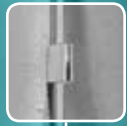



SSSFGCW1S One Hole Glass Connector - Page 15



SSSFH180 Standard 180° Hinge - Page 5



SSSFTBSQ Square Towel Bar Handle - Page 23



SSSFSS1 Glass to glass 180° door seal with lip and fin - Page 29



GESCS1700 Clear GE Silicone - Page 41

All products in this catalogue are shown in Chrome Polished (CP), but are available in all 3 finishes below:

3 Hinges

13 Glass Connectors

19 Handles, Knobs & Hangers

27 Seals, Sweeps & Gaskets

31 Sliding Shower Door Kits & More

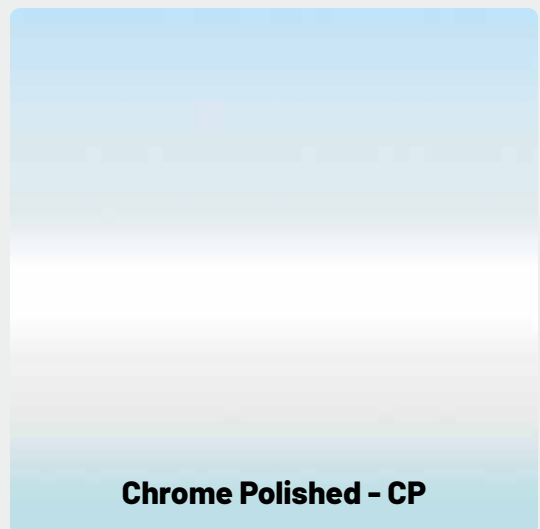
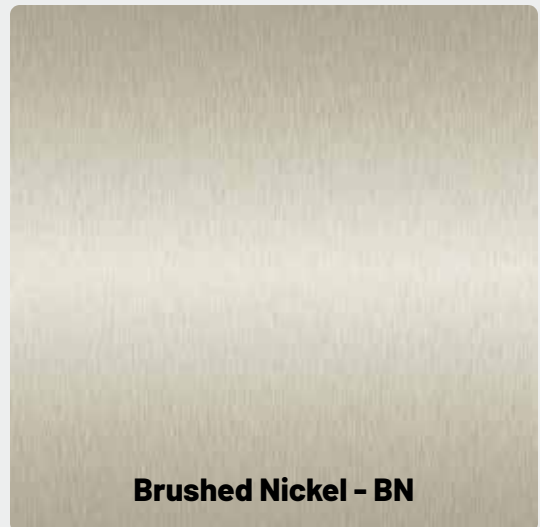

Product codes in this catalogue are displayed without colour codes. Simply add colour codes above to the end of the product codes (B, BN, CP).

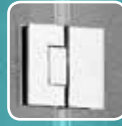

SSSFH180 Standard 180° Hinge - Page 5

HINGES

Euro's *STANDARD* and *HEAVY DUTY* hinges come with 4 installed Allen screws, 4 Phillips screws, black rubber gaskets, and clear PVC gaskets.

Our *COVERED* series offers an elegant, modern touch with a cover plate concealing the screws (Page 7).

Diagrams, cut-outs, and more details are available on our website euroeac.com.

Available in:
Matte Black (B),
Brushed Nickel (BN),
Chrome Polished (CP).



HINGES Standard Series

GLASS THICKNESS: 8 - 10mm • DOOR WEIGHT: 45 kg max. per pair • SOLID BRASS

SSSFHW • Glass to Wall • Full Back Plate • Swings 90° in + 90° out • Self-centering within 15° of closed

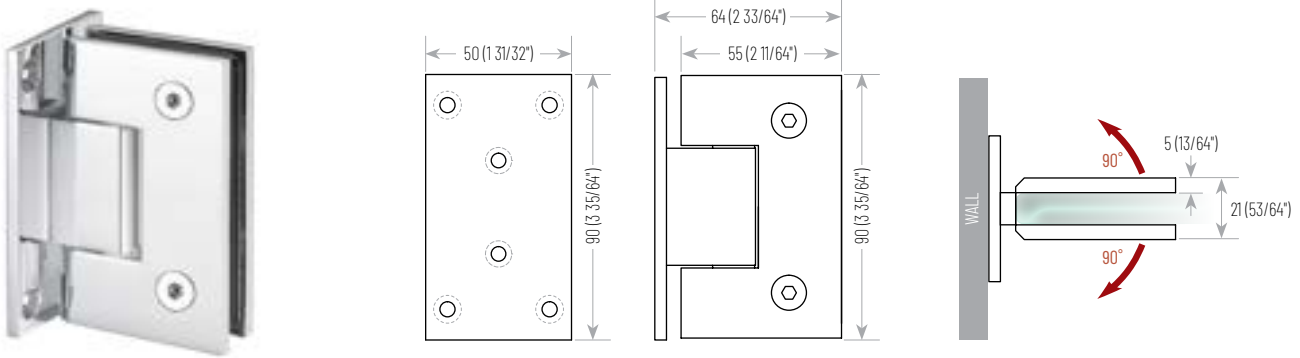

SSSFH180 • Glass to Glass 180° • Swings 90° in + 90° out • Self-centering within 15° of closed

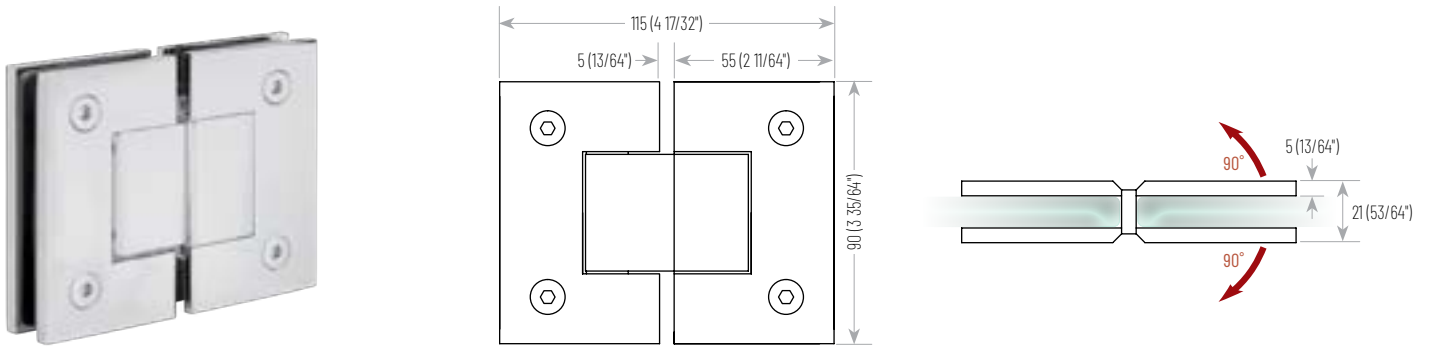

SSSFH135 • Glass to Glass 135° • Swings 90° in + 90° out • Self-centering within 15° of closed

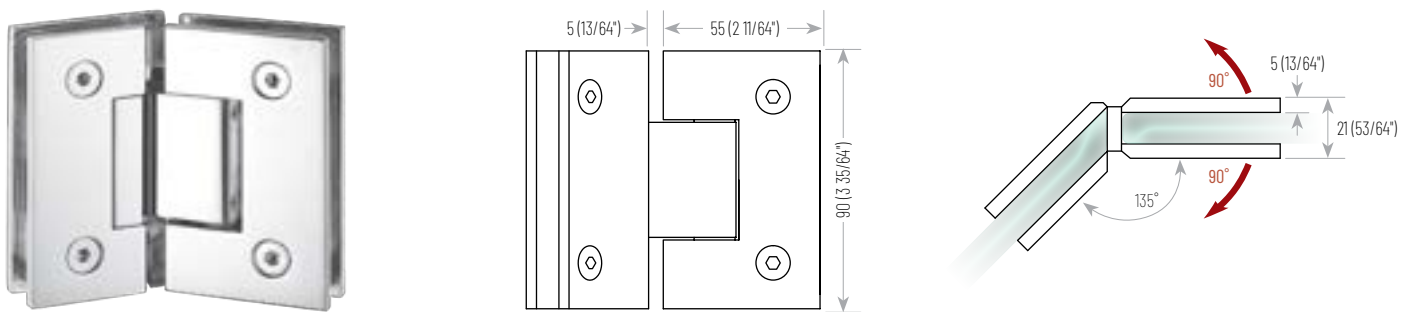

SSSFH90 • Glass to Glass 90° • Swings 90° in + 90° out • Self-centering within 15° of closed

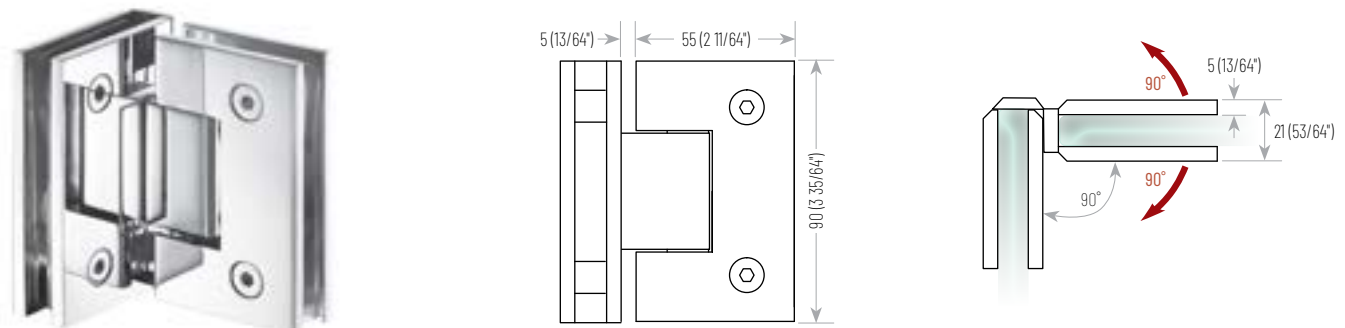

SSSFHWH • Glass to Wall • H-Clip Back Plate • Swings 90° in + 90° out • Self-centering within 15° of closed

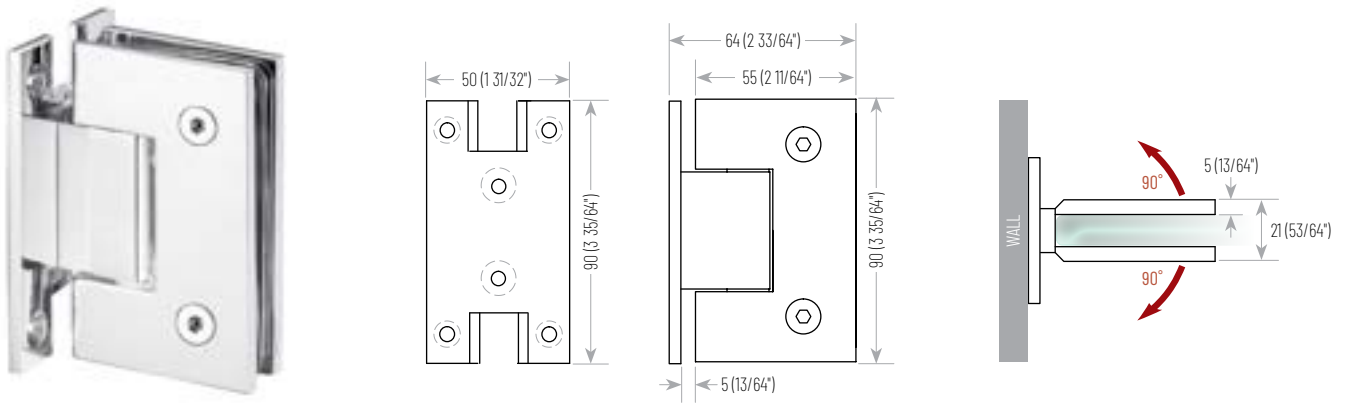

SSSFHWSP • Glass to Wall • Short Back Plate • Swings 90° in + 90° out • Self-centering within 15° of closed

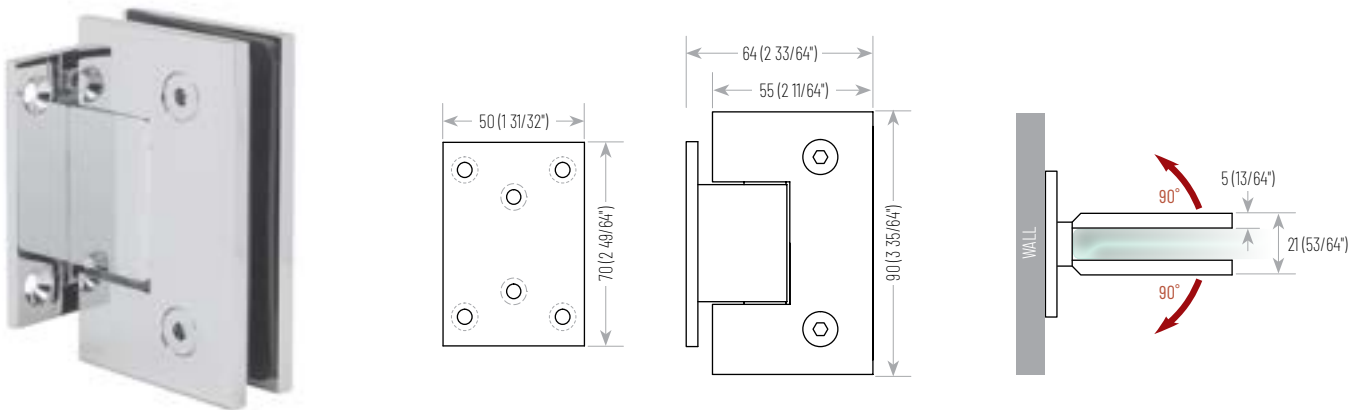

SSSFHWOFS • Glass to Wall • Offset Back Plate • Swings 90° in + 90° out • Self-centering within 15° of closed

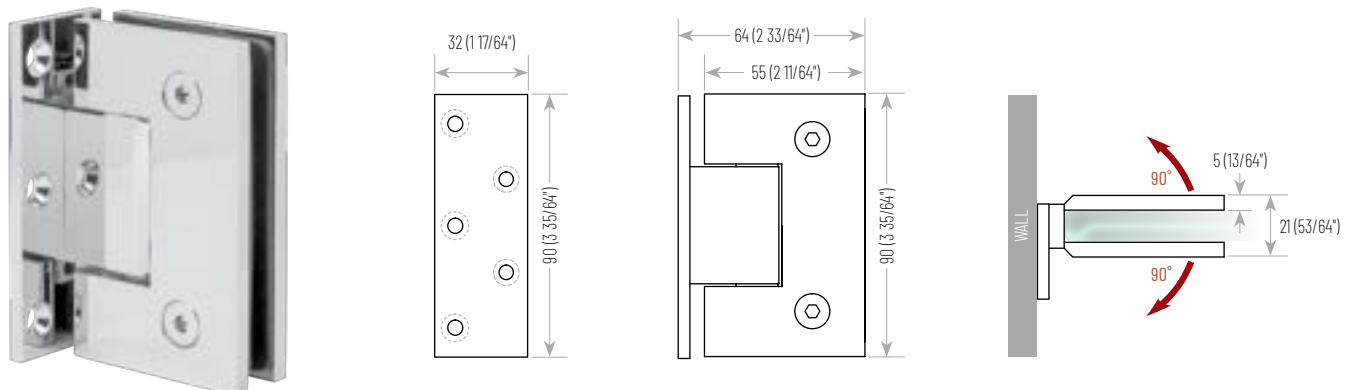

HINGES Covered Series

GLASS THICKNESS: 8 - 10mm • DOOR WEIGHT: 45 kg max. per pair • SOLID BRASS

SSSFHCW • Glass to Wall • Offset • Swings 90° in + 90° out • Self-centering within 15° of closed

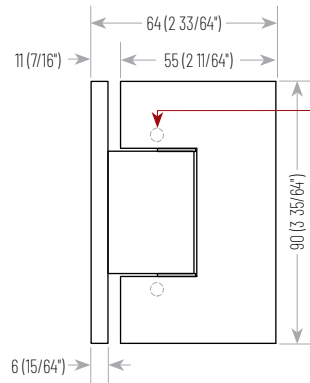

Walls are never perfectly straight. The Allen Adjustment Screws inside allows angling of door with near precision up to ± 90° without having to remove the door.

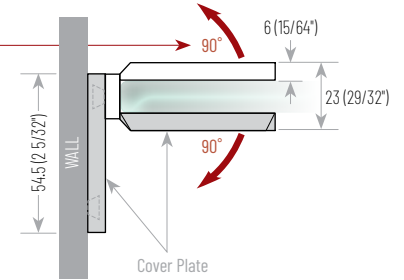

SSSFHC180 • Glass to Glass 180° • Swings 90° in + 90° out • Self-centering within 15° of closed

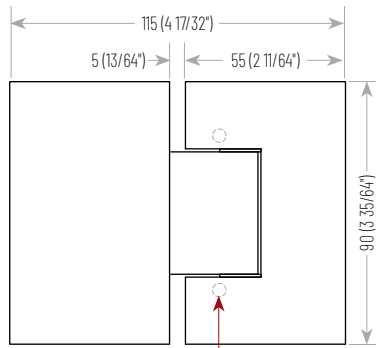

Allen Adjustment Screws Inside

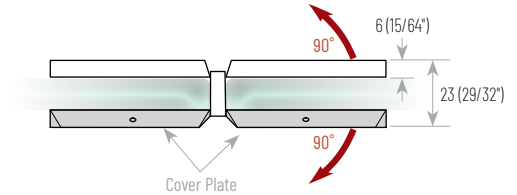

SSSFHC135 • Glass to Glass 135° • Swings 90° in + 90° out • Self-centering within 15° of closed

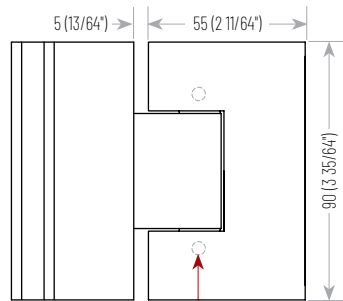

Allen Adjustment Screws Inside

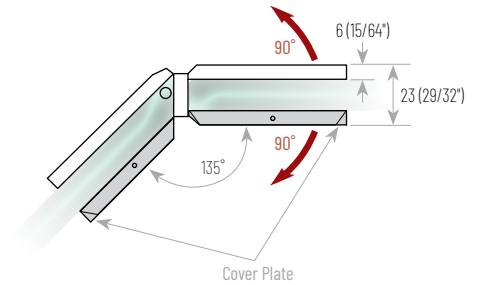

SSSFHC90 • Glass to Glass 90° • Swings 90° in + 90° out • Self-centering within 15° of closed

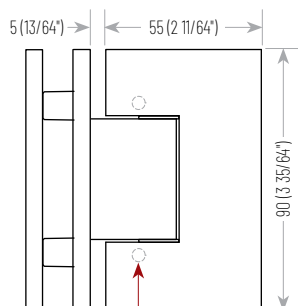

Allen Adjustment Screws Inside

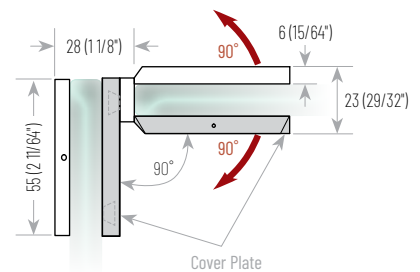



HINGES Heavy Duty Series

GLASS THICKNESS: 8 - 12mm • DOOR WEIGHT: 50 kg max. per pair • SOLID BRASS

SSSFHWL • Glass to Wall • Full Back Plate • Swings 90° in + 90° out • Self-centering within 15° of closed

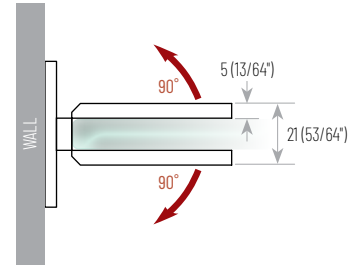
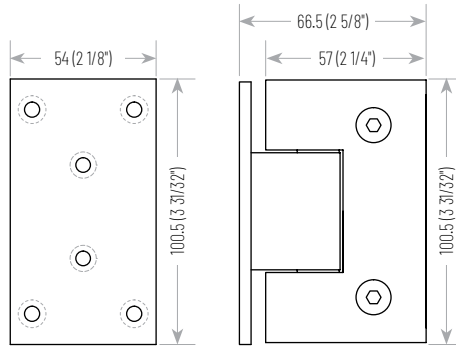

SSSFH180L • Glass to Glass 180° • Swings 90° in + 90° out • Self-centering within 15° of closed

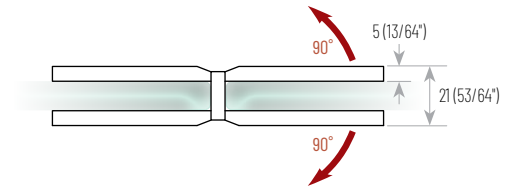
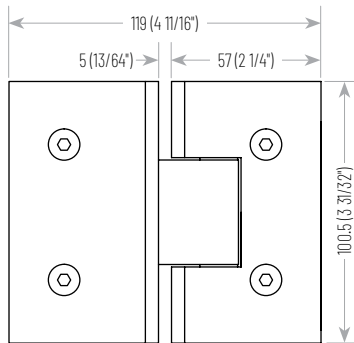

SSSFH135L • Glass to Glass 135° • Swings 90° in + 90° out • Self-centering within 15° of closed

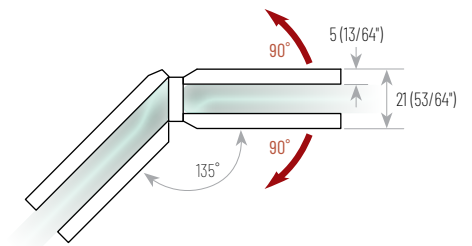
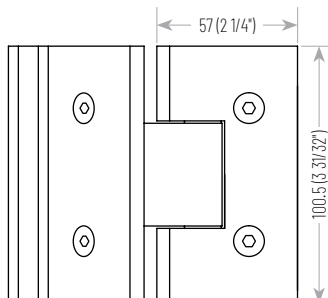

SSSFH90L • Glass to Glass 90° • Swings 90° in + 90° out • Self-centering within 15° of closed

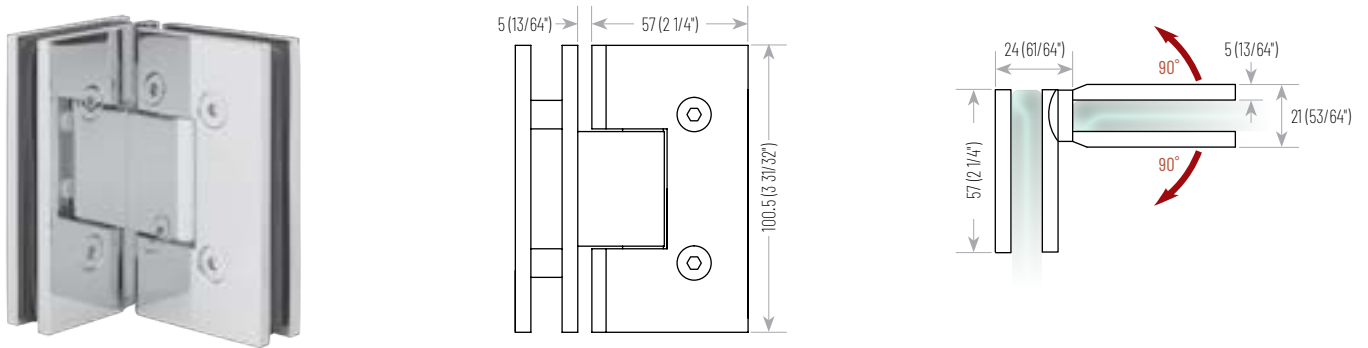

SSSFHWSPL • Glass to Wall • Short Back Plate • Swings 90° in + 90° out • Self-centering within 15° of closed

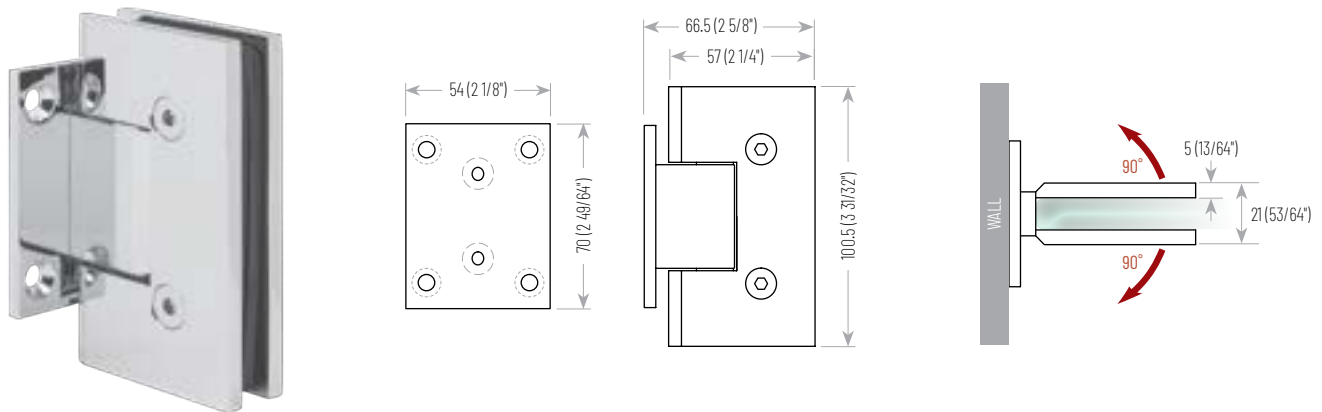

SSSFHWOFSL • Glass to Wall • Offset Back Plate • Swings 90° in + 90° out • Self-centering within 15° of closed

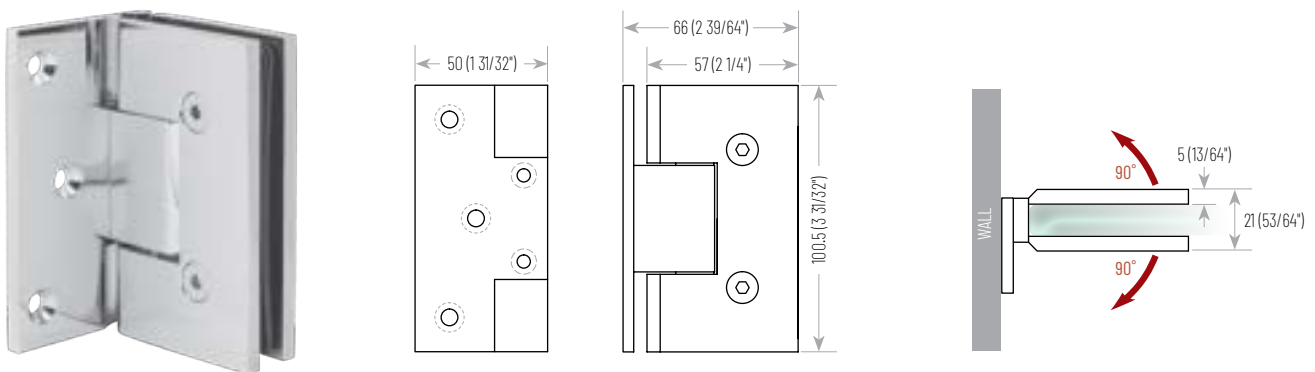

PIVOT HINGE

GLASS THICKNESS: 8 - 10mm • DOOR WEIGHT: 45 kg max. per pair • SOLID BRASS



All Available in:



Matte Black (B)



Brushed Nickel (BN)



Chrome Polished (CP)



SSSFHTB • Pivot Hinge • Top or Bottom Mount • Full Rotation • Self-centering within 15° of closed

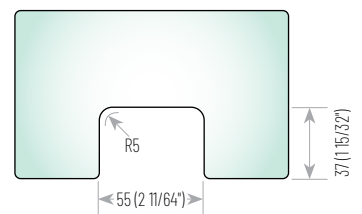
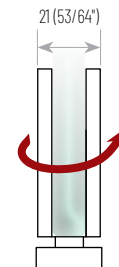
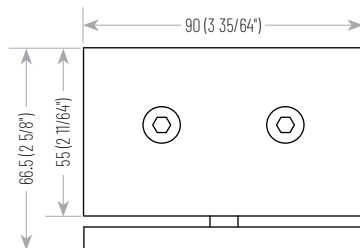

SWING HINGE

GLASS THICKNESS: 8 - 10mm • DOOR WEIGHT: 45 kg max. per pair • SOLID BRASS



All Available in:



SSSFHFB180 • Glass to Glass 180° • Free Swinging Hinge • One-Sided Opening Outwards 90°

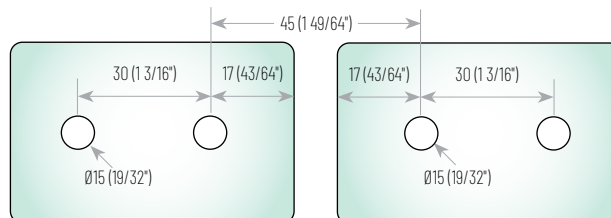
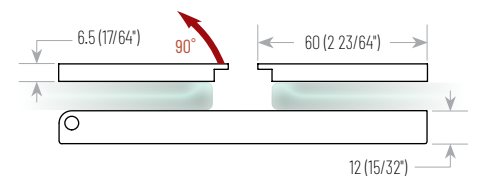
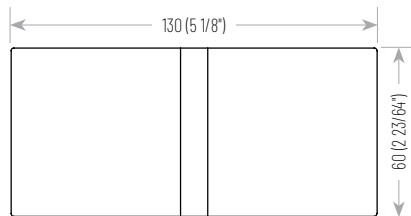



GLASS CONNECTORS

Glass connectors offer a modern look for frameless shower door systems. Available in a variety of designs, we offer traditional glass connectors as well as inside fit and sleeve over glass.

Diagrams, cut-outs, and more details are available on our website euroeac.com.

*Available in:
Matte Black (B),
Brushed Nickel (BN),
Chrome Polished (CP).*



GLASS CONNECTORS

GLASS THICKNESS: 8 - 10mm • INCLUDES: Mounting screws & gaskets • SOLID BRASS

SSSFGCW1S • Glass to Wall • One Hole

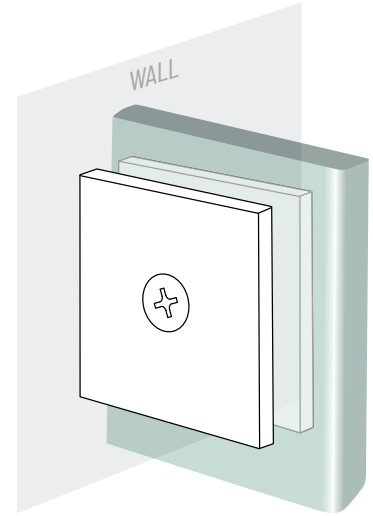
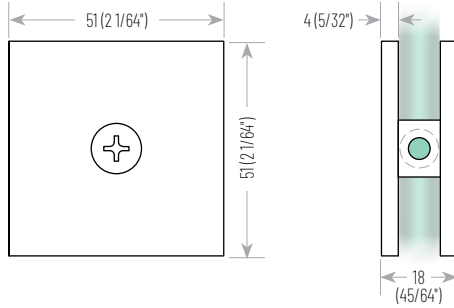

SSSFGCW2S • Glass to Wall • Two Holes

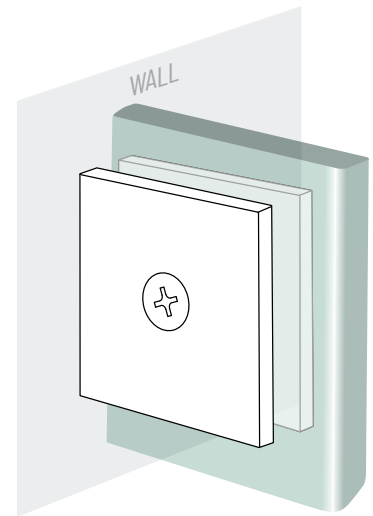
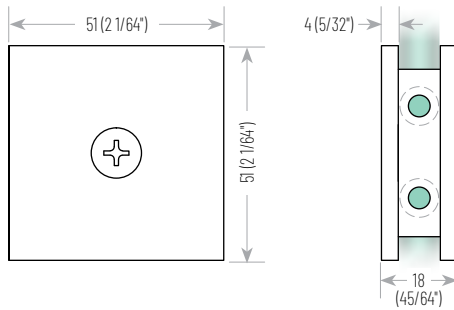

SSSFGC180S • Glass to Glass 180°

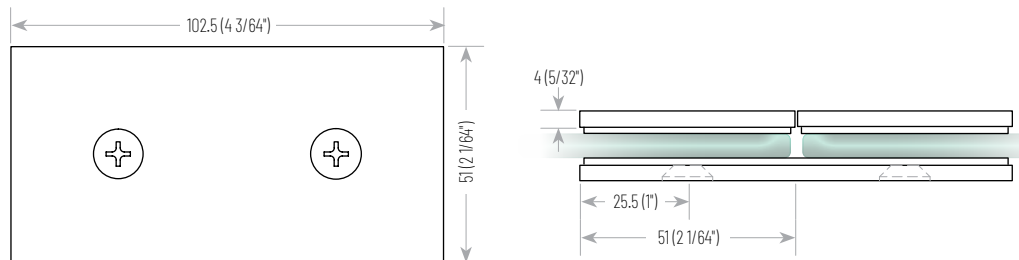

SSSFGC135S • Glass to Glass 135°

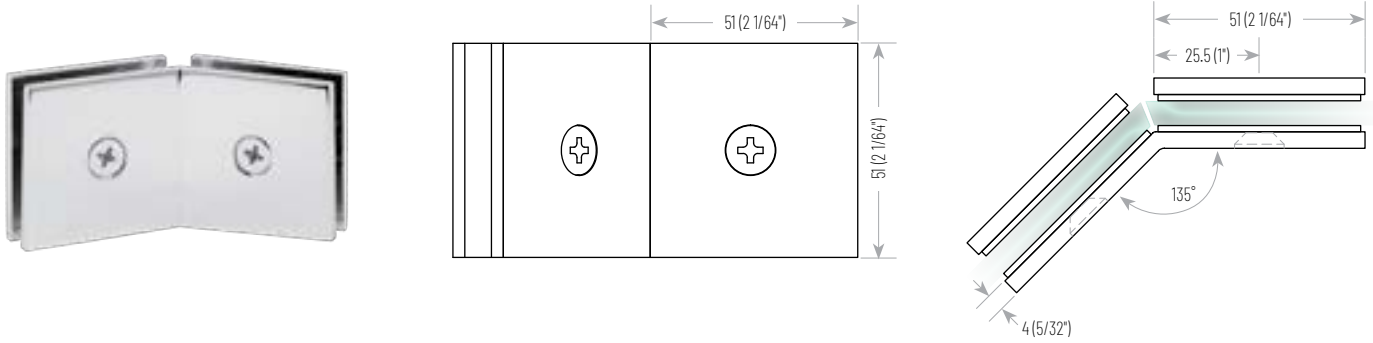

SSSFGC90S • Glass to Glass 90°

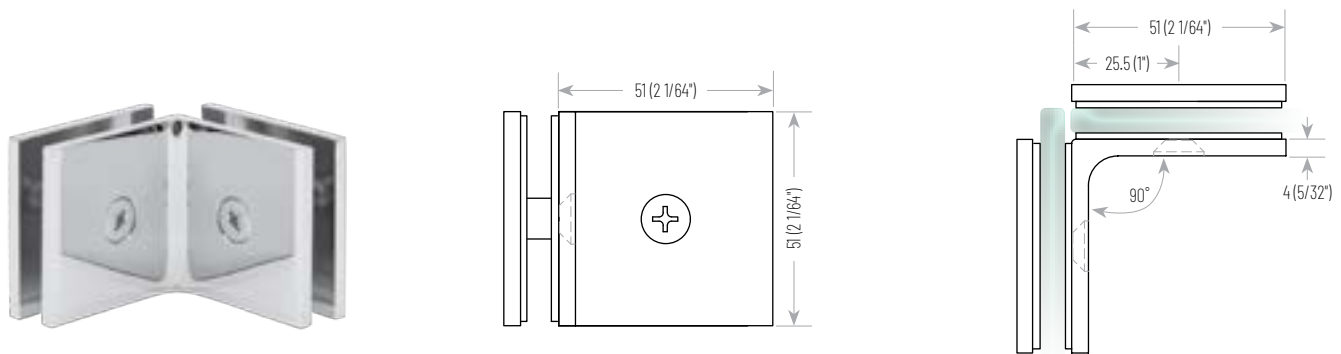

SSSFGC190 • Glass to Glass 90° • Inside Fit

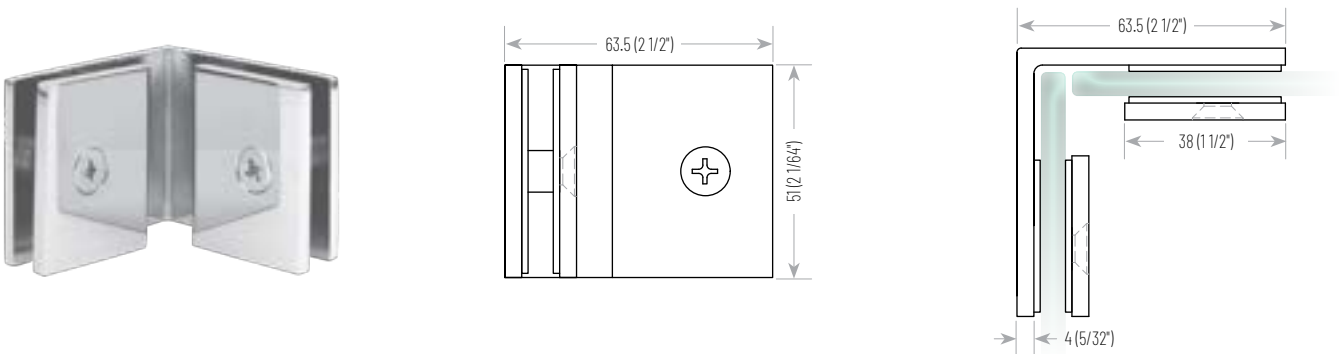

SLEEVE OVER GLASS CLAMPS

GLASS THICKNESS: 8 - 10mm • SOLID BRASS

SSSFSOG180 • Glass to Glass 180° • Includes 1 Phillips screw and drywall sleeve

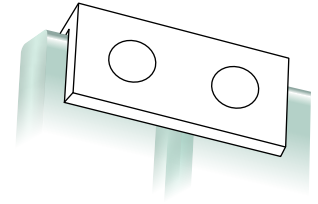
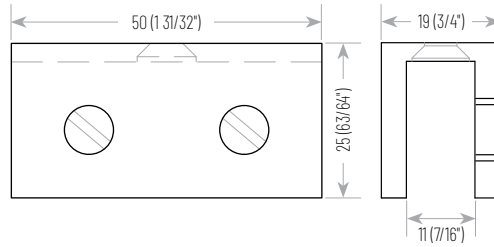

SSSFSOG90 • Glass to Glass 90°

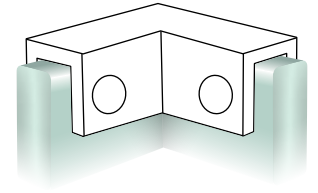
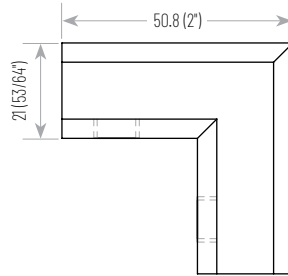

SSSFSOGADJ • Glass to Glass Adjustable

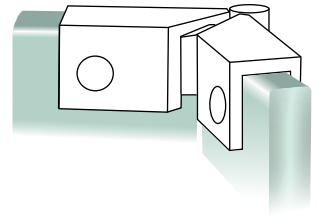
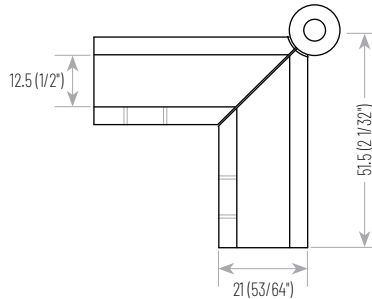

SSSFSOGWL • Glass to Wall 90° LEFT • Includes 1 Phillips screw and drywall sleeve

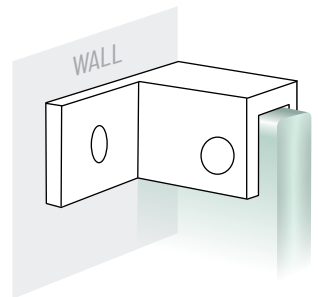
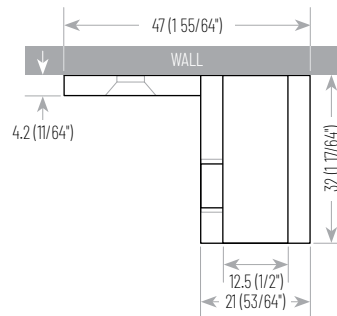

SSSFSOGWR • Glass to Wall 90° RIGHT • Includes 1 Phillips screw and drywall sleeve

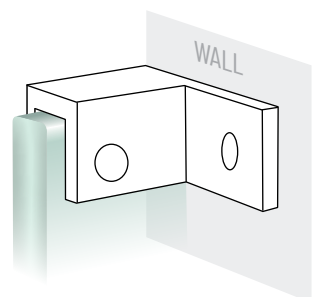
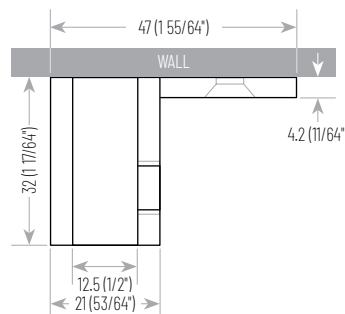



A



B

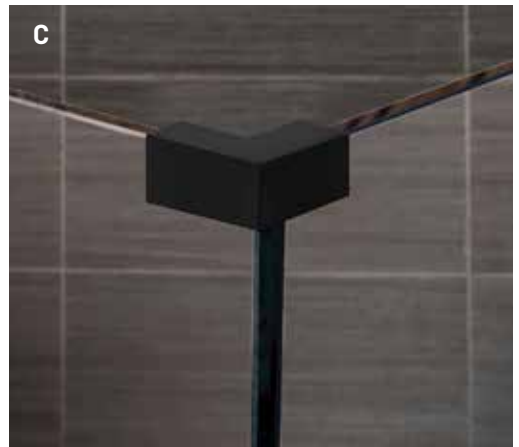

C

A. SSSFGCW1S

One Hole Glass to Wall (Page 15)

B. SSSFGCW2S

Two Holes Glass to Wall (Page 15)

C. SSSFSOG90

90° Glass to Glass (Page 17)



SSSFTBSQ Towel Bar/Handle - Page 23

HANDLES, KNOBS & HANGERS

Our quality shower door pull handles, knobs, and matching towel hangers are available in round, square, or mitered to complement your decor. They are easy to install and are suitable for 6 - 12mm glass.

Diagrams, cut-outs, and more details are available on our website euroeac.com.

*Available in:
Matte Black (B),
Brushed Nickel (BN),
Chrome Polished (CP).*



D-TYPE PULL HANDLES

GLASS THICKNESS: 6 - 12mm • HOLE DIAMETER: 12mm • Includes metal washers

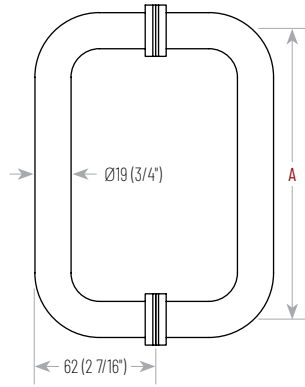

ROUND

Model	Height A
SSSFDHD6	152 (6")
SSSFDHD8	203 (8")
SSSFDHD12	305 (12")
SSSFDHD18	457 (18")
SSSFDHD24	610 (24")

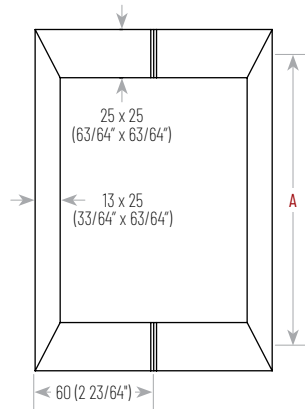

SQUARE

Model	Height A
SSSFDHSQD6	152 (6")
SSSFDHSQD8	203 (8")
SSSFDHXD12	305 (12")
SSSFDHXD18	457 (18")
SSSFDHXD24	610 (24")

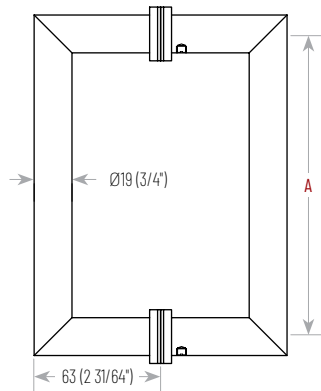

MITERED

Model	Height A
SSSFDHDM6	152 (6")
SSSFDHDM8	203 (8")
SSSFDHDM12	305 (12")
SSSFDHDM18	457 (18")
SSSFDHDM24	610 (24")

LADDER TYPE PULL HANDLES

GLASS THICKNESS: 6 - 12mm • HOLE DIAMETER: 12mm • Includes metal washers

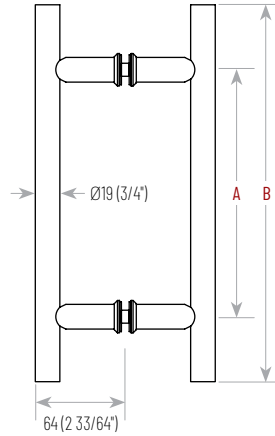

ROUND

	<u>A</u>	<u>B</u>
SSSFDHL8	203 (8")	305 (12")
SSSFDHL12	305 (12")	457 (18")
SSSFDHL18	457 (18")	610 (24")

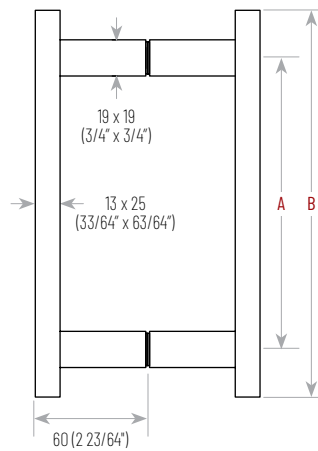

SQUARE

	<u>A</u>	<u>B</u>
SSSFDHSQ8	152 (6")	203 (8")
SSSFDHSQ12	254 (10")	305 (12")

DUAL-SIDED TOWEL BAR PULL HANDLES

GLASS THICKNESS: 6 - 12mm • HOLE DIAMETER: 12mm • Includes metal washers

ROUND

- SSSFTB6X18** • 6" Pull Handle with 18" Towel Bar 152 (6")
- SSSFTB8X18** • 8" Pull Handle with 18" Towel Bar 203 (8")

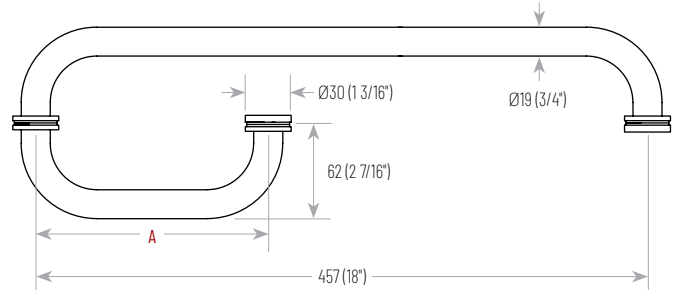

SQUARE

- SSSFTBSQ** • 8" Pull Handle with 15 3/4" Towel Bar

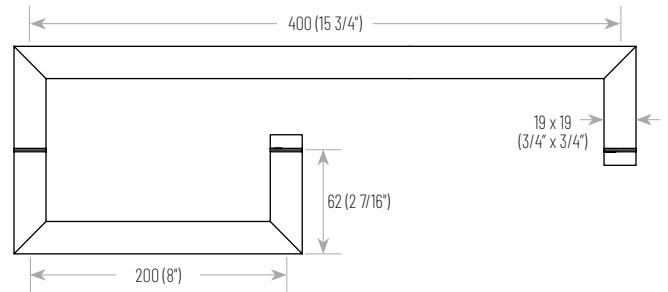

Metal washers not included

MITERED

- SSSFTBMT** • 6" Pull Handle with 18" Towel Bar

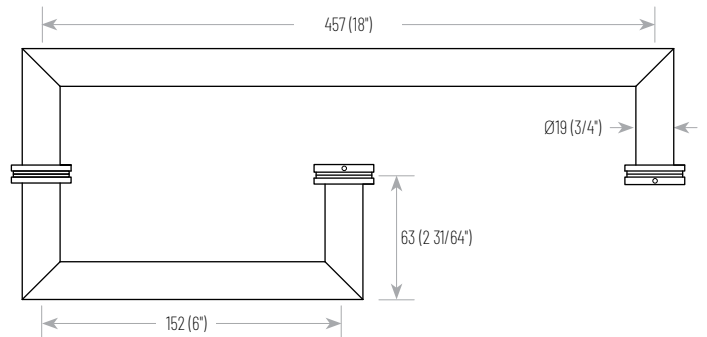

SINGLE-SIDED TOWEL BAR PULL HANDLES

GLASS THICKNESS: 6 - 12mm • HOLE DIAMETER: 12mm • Includes metal washers

ROUND

	<u>A</u>
SSSFTB12R	305 (12")
SSSFTB18R	457 (18")
SSSFTB24R	610 (24")

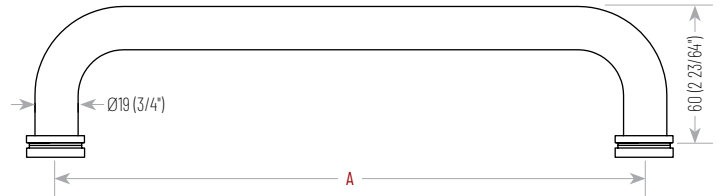

SQUARE

	<u>A</u>
SSSFTB12S	305 (12")
SSSFTB18S	457 (18")
SSSFTB24S	610 (24")

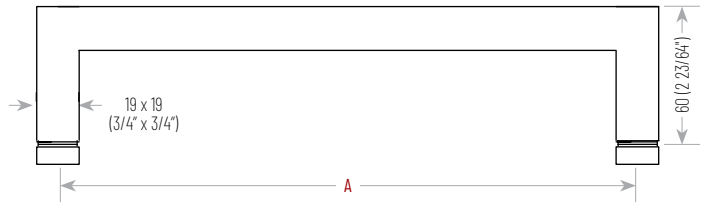

Metal washers not included

MITERED

	<u>A</u>
SSSFTB12M	305 (12")
SSSFTB18M	457 (18")
SSSFTB24M	610 (24")

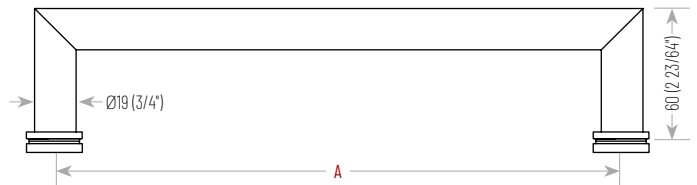

KNOBS

GLASS THICKNESS: 6 - 12mm • HOLE DIAMETER: 12mm • Includes metal washers

SSSFDK1 • ROUND Modern Knob

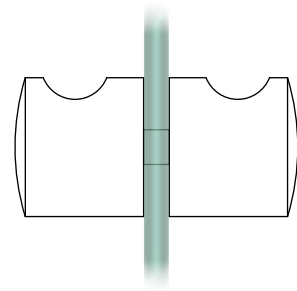
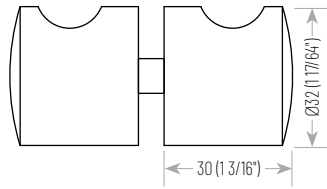

SSSFDK2 • ROUND Grooved Knob

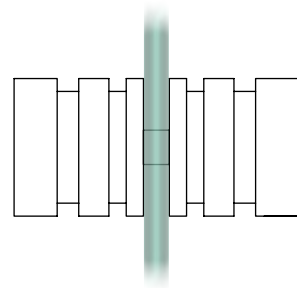
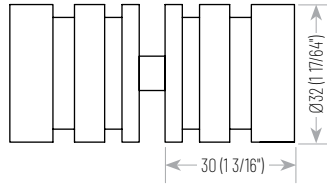

SSSFDK3 • ROUND Traditional Knob

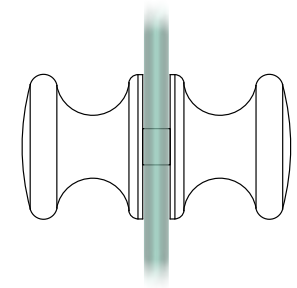
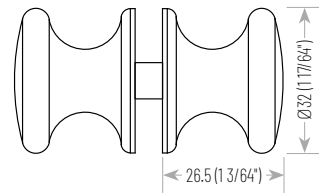

SSSFDKSQ • SQUARE Traditional Knob

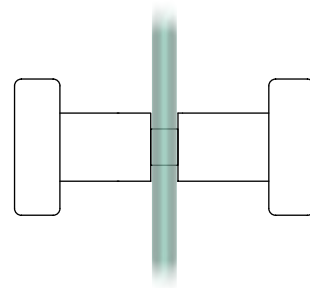
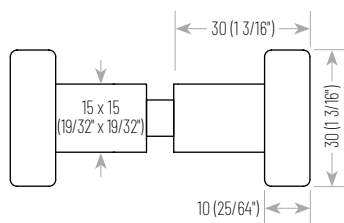

TOWEL HANGERS

GLASS THICKNESS: 6 - 12mm • HOLE DIAMETER: 12mm

SSSFDRND • Off-the-glass Round Towel Hanger

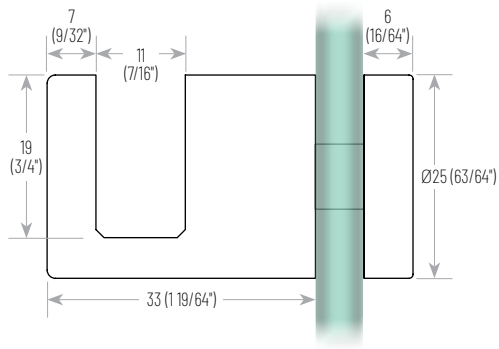

SSSFDTSQR • Off-the-glass Square Towel Hanger

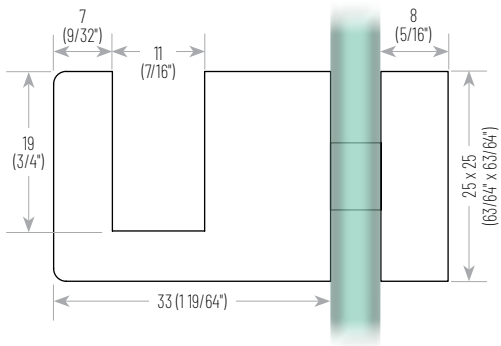



SSSFSS1 Glass to glass 180° door seal with lip and fin - Page 29

SEALS, SWEEPS & GASKETS

We offer a variety of seals, sweeps, and gaskets to secure your shower door enclosure. Strips come in 98" lengths and are suitable for 8 - 10mm glass. They have UV protection and help to prevent water leakage. Gaskets come in 300' spools and are suitable for 8 - 12mm glass.

More details are available on our website euroeac.com.



SEALS, SWEEPS & GASKETS

GLASS THICKNESS: 8 - 10mm • SEALS & SWEEPS LENGTH: 98" • GASKETS LENGTH: 300' Spools

SSSFSS1 • Glass to glass 180° door seal with lip and fin

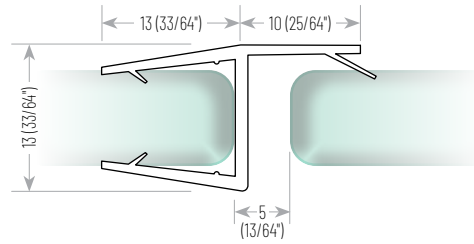

SSSFSS2 • Glass to glass 180° door seal with leg

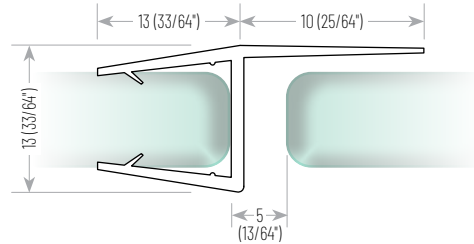

SSSFSS3 • Glass to floor door sweep with single middle fin

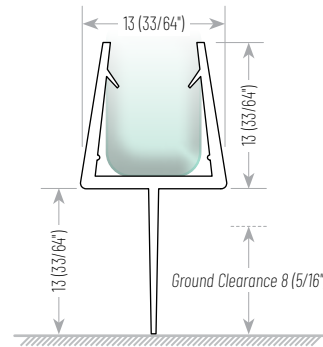

SSSFSS4 • Glass to floor door sweep with flexible leg

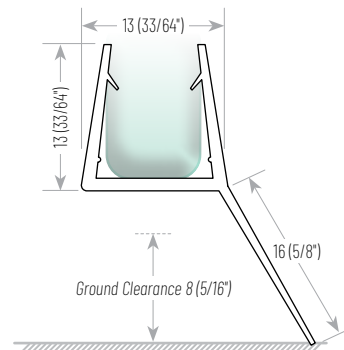

SSSFSS5 • Glass to floor door sweep with 2 legs and drip rail

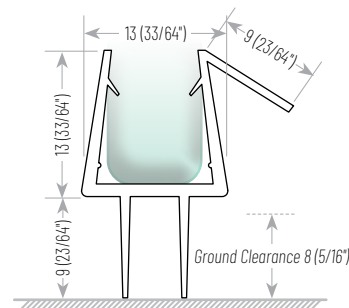

SSSFSS6 • Glass to floor door sweep with bulb seal

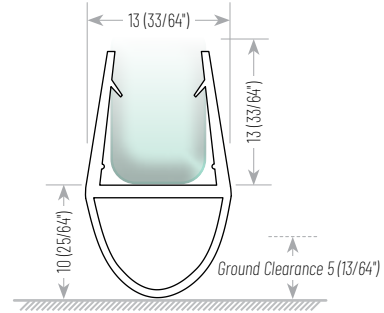

SSSFSS7 • Glass to glass 90° door seal

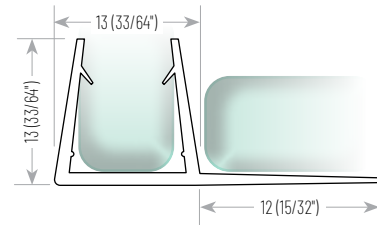

SSSFSS8 • Glass to glass 180° H seal

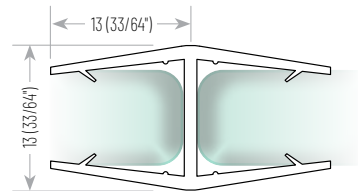

SSSFSS9 • Glass to floor door sweep with double fin and large drip rail
FOR 10mm GLASS ONLY

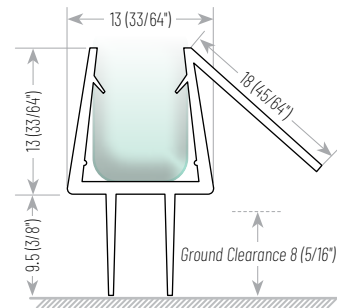

SSSFSSA • Glass to wall translucent gasket *without* adhesive strip • **GLASS THICKNESS: 8 - 12mm** • **COMES IN: 300' Spools**

SSSFSSB • Glass to wall translucent gasket *with* adhesive strip • **GLASS THICKNESS: 8 - 12mm** • **COMES IN: 300' Spools**

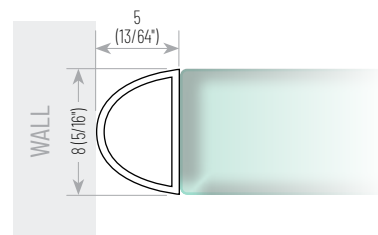



Riveo Aqua 01 Pro Sliding Shower Door Kit - Page 33

SLIDING SHOWER DOOR KITS & MORE

Our sleek and modern shower door kits come in various finishes. Complete your project with our clear silicone, which provides protection from mold and mildew. Keep your glass looking fresh and clean with our top-grade glass cleaner for a streakless shine.

More details are available on our website euroeac.com.

*Available in:
Matte Black (B),
Brushed Nickel (BN),
Chrome Polished (CP).*



RIVEO AQUA 01 PRO SLIDING SHOWER DOOR KIT

GLASS THICKNESS: 8 - 10mm



Modernize your shower with the Riveo Aqua 01 Pro. Made of 304 grade stainless steel, this is a stylish and affordable addition to your home. Available in Matte Black, Brushed Nickel, and Chrome Polished.



SSSFSD1
RIVEO AQUA 01 PRO

SINGLE sliding door with fixed panel and thru-glass pull

- Clean, streamlined look.
- Maximizes small spaces.
- Panels are reversible for left or right opening.
- Can be installed in a bath/shower unit or a stand-alone shower.
- Glass drilling required.
- For use with 5/16" (8mm) or 3/8" (10mm) glass.
- Max. door height: 78 3/4" (2000mm).
- Max. door width: 37 3/4" (960mm).
- Max. door capacity: 88 lbs (40 kg) per door.

See our website for more information.

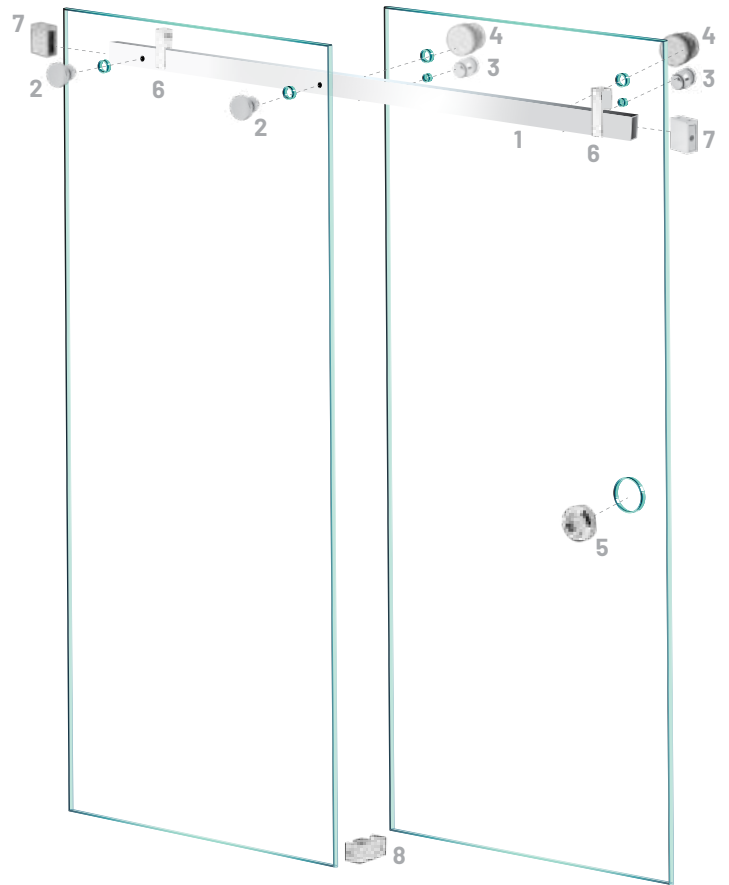

KIT INCLUDES:

1. (1x) Header Bar 78 3/4" (2m)

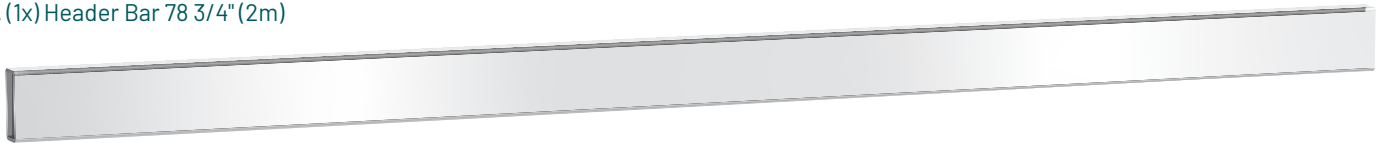

2. (2x) Track Holder Fittings for Fixed Panel



3. (2x) Anti-jumps



4. (2x) Rollers
EXTRA ROLLERS FOR INCREASED STABILITY AVAILABLE (SSSFSD12)



5. (1x) Thru-Glass Pull



6. (2x) Stoppers



7. (2x) Track Holder Fittings for Wall



8. (1x) Door Guide



SSSFSD13
End Cap for 90° Glass Return
SOLD SEPARATELY

RIVEO GALAXY PRO SLIDING SHOWER DOOR KIT

GLASS THICKNESS: 10mm

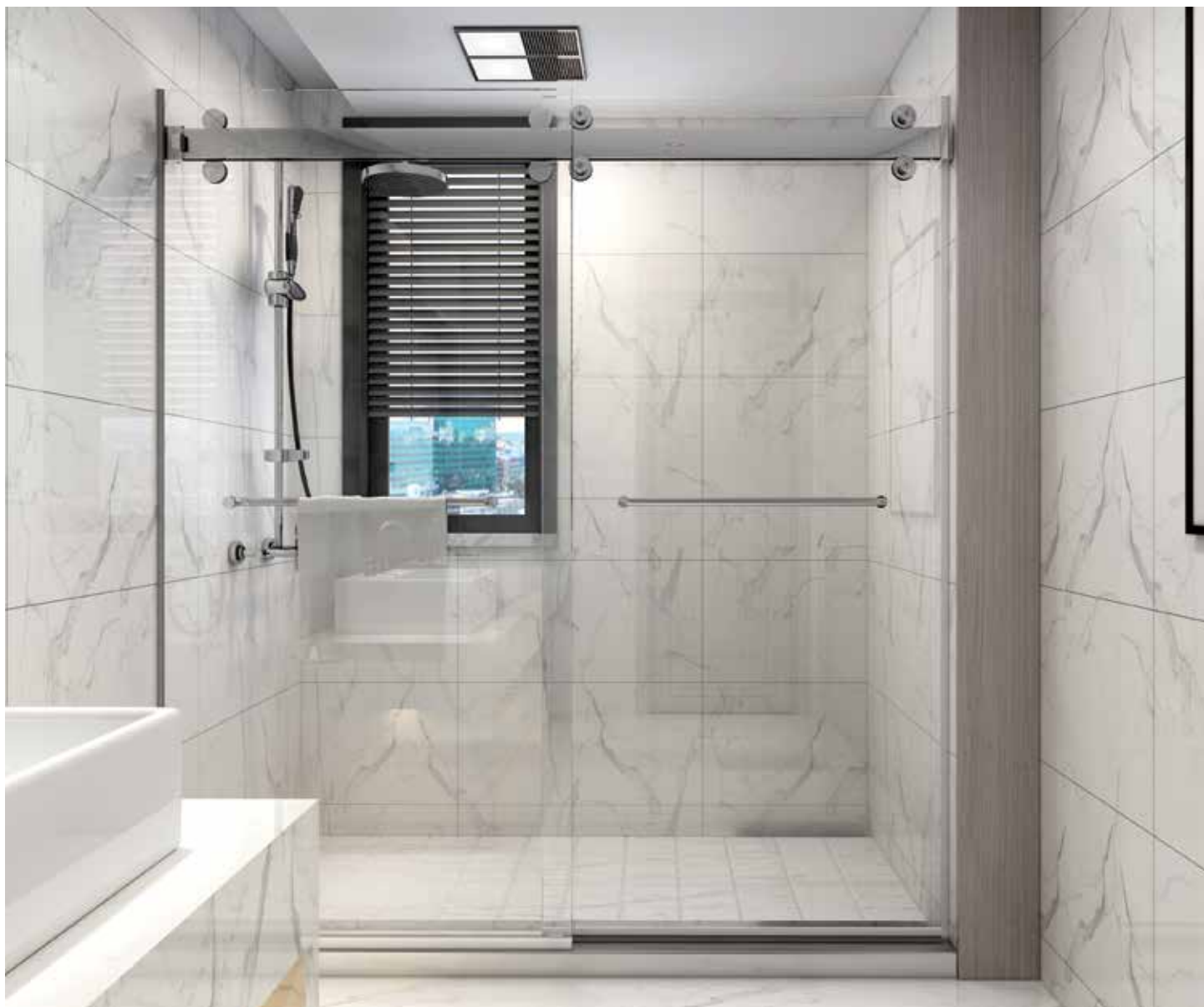

The Riveo Galaxy Pro system maximizes small spaces with a clean, streamlined look. Perfect for installation in a bath/shower, this stylish kit, available in Matte Black and Chrome Polished, allows access through either the left or right door, creating the illusion of space in small areas.



SSSFSD2

RIVEO GALAXY PRO

DOUBLE sliding door with 2 handles

Available ONLY in Matte Black (B) and Chrome Polished (CP)

- Clean, streamlined look.
- Maximizes small spaces.
- Allows access by both the left and/or right door.
- Can be installed in a bath/shower unit or a stand-alone shower.
- Glass drilling required.
- For use with 5/16" (8mm) or 3/8" (10mm) glass.
- Max. door height: 78 3/4" (2000mm).
- Max. door width: 37 3/4" (960mm).
- Max. door capacity: 88 lbs (40 kg) per door.

See our website for more information.

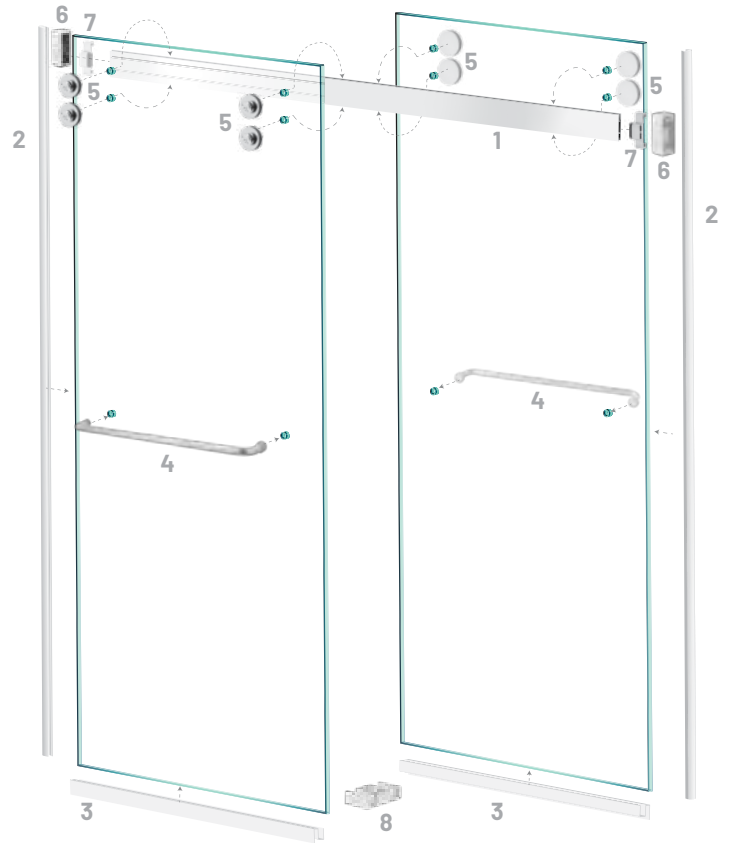

KIT INCLUDES:

1. (1x) Header Bar 74 3/16" (1.8m)



2. (2x) Glass to Wall Sealers



3. (2x) Glass to Floor Sealers



4. (2x) Round Handles

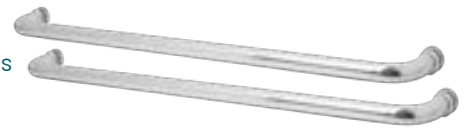

5. (8x) Rollers



6. (2x) Track Holder Fittings for Wall



7. (2x) Stoppers



8. (1x) Door Guide with 2 Screws & 2 Anchors



(1x) Roller Adjustment Tool



(4x) Sets of Screws with Anchors



(1x) 2.5mm + (1x) 4mm Allen key

HEADER KIT

AVAILABLE IN: Matte Black, Brushed Nickel, Chrome Polished

SSSFCH103 • D Profile Header Kit 98" • **GLASS THICKNESS:** 8 - 12mm



SSSFHTB • Pivot Hinge • Top or Bottom Mount
Full Rotation • Self-centering within 15° of closed

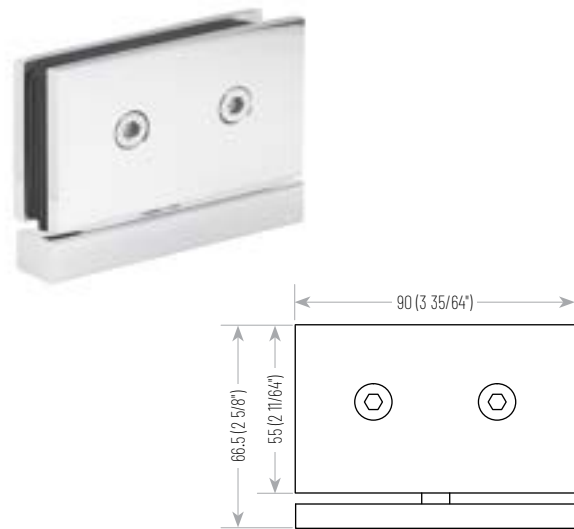

SSSFHTBV • Beveled Pivot Hinge • Top or Bottom Mount
Full Rotation • Self-centering within 15° of closed

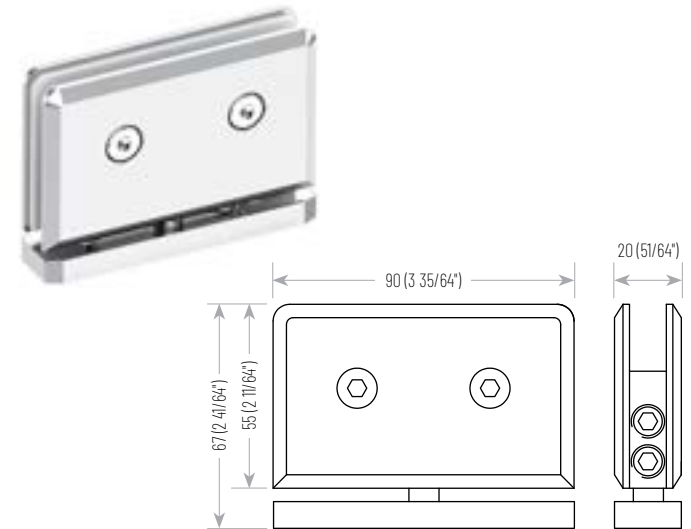

SSSFCH103D
Wall Brackets for CH103 Header Kit



SSSFCH103E
90° Elbow for CH103 Header Kit
SSSFCH103F
Adjustable Elbow for CH103 Header Kit



SSSFCH103G
Hinge Adaptor for CH103 Header Kit





CHANNELS

AVAILABLE IN: Clear Anodized Aluminum (CA), Black Anodized Aluminum (B), Brushed Nickel (BN), Chrome Polished (CP).



Shown in
Black Anodized Aluminum (B).

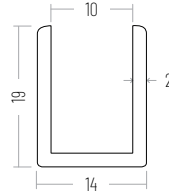

Not available in Clear Anodized Aluminum (CA).

PART#	Width	Height	Glass Size	Length
SSSFCH101	9/16"	3/4"	10mm	98"
SSSFCH102	9/16"	3/4"	10mm	144"

SSSFCH101E Matching End Cap Available.



Shown in
Clear Anodized Aluminum (CA).

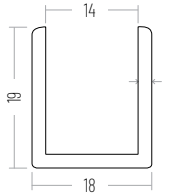

PART#	Width	Height	Glass Size	Length
SSGWCH5834	11/16"	3/4"	10mm	144"



Shown in
Brushed Nickel (BN).

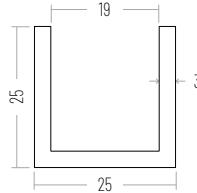

PART#	Width	Height	Glass Size	Length
SSGWCH11	1"	1"	10-12mm	144"

SSGWCH11E Matching End Cap Available.



Shown in
Chrome Polish (CP).

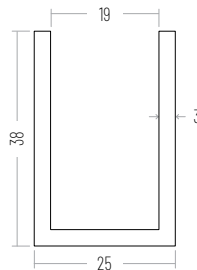

PART#	Width	Height	Glass Size	Length
SSGWCH112	1"	1 1/2"	10-12mm	144"

SSGWCH112E Matching End Cap Available.



Shown in
Black Anodized Aluminum (B).

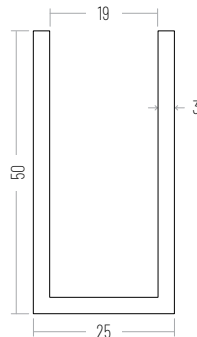

PART#	Width	Height	Glass Size	Length
SSGWCH12	1"	2"	10-12mm	144"

SSGWCH12E Matching End Cap Available.



Shown in
Clear Anodized Aluminum (CA).

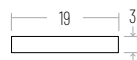

Aluminum Flat Bar Available in CA & B only.

PART#	Width	Height	Glass Size	Length
SSGWFL34	3/4"	1/8"	NA	144"

Glazing Rubber Gaskets • For use with SSGWCH Channels (Page 39)

SSGWCHSEAL1 • Glazing Gasket for 10mm Glass • **COMES IN:** 100' Rolls

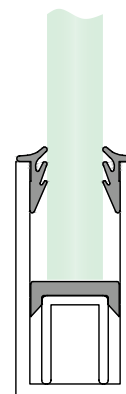
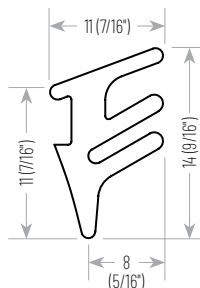
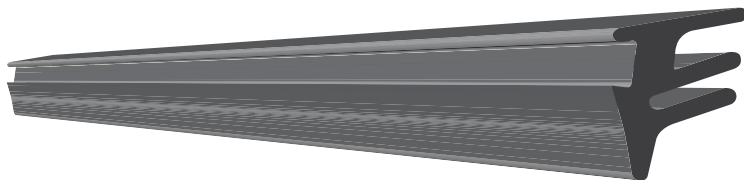

SSGWCHSEAL2 • Glazing Gasket for 12mm Glass • **COMES IN:** 100' Rolls

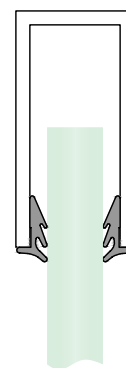
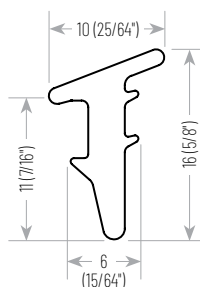
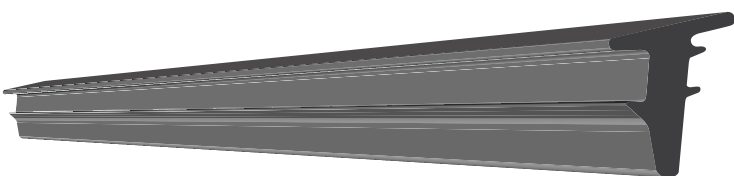

Rubber Setting Blocks

COME IN: Bags of 10 units • **LENGTH:** 100mm (4")

SSGWCHSEAL3 • Glazing Setting Blocks

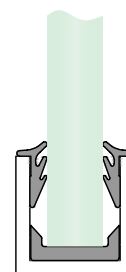
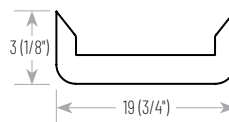
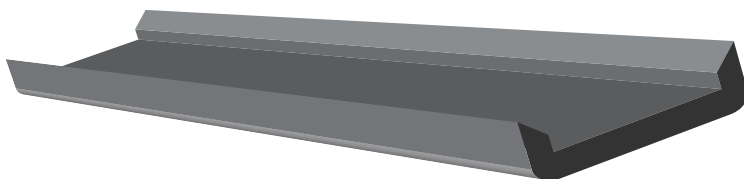

Clear PVC Setting Blocks • For use with SSSFCH Channels (Page 39)

COME IN: Bags of 100 units • **LENGTH:** 50.8mm (2")



Clear setting blocks are used to level glass panels during the installation of shower stalls and mirrors. Various thicknesses are available to help you obtain a perfect and discreet alignment thanks to their transparency.

	<u>THICKNESS</u>
SSSFCHSET1	0.04"
SSSFCHSET2	1/8"
SSSFCHSET3	5/32"
SSSFCHSET4	1/4"
SSSFCHSET5	3/8"

SILICONE & CLEANER

GESCS1700

Clear GE SCS1700 Silicone • Mold & Mildew Resistant
299mL Cartridge



GGCLEANER

Sprayway Glass Cleaner
19oz Spray Can



*Personalized labelling
options available on
Sprayway Glass Cleaner.*









CUSTOM TEMPERED GLASS SHOWER PANELS & DOORS

- Safety tempered glass.
- Available thickness: 8 - 12mm.
- Custom sizes & shapes.
- Custom hinge cut-outs and drilled holes as per your drawings.
- Contact us for further details.



INDEX

<u>PART #</u>	<u>PAGE</u>	<u>PART #</u>	<u>PAGE</u>	<u>PART #</u>	<u>PAGE</u>
GESCS1700	41	SSSFDHSQ8	22	SSSFHWSP	6
GGCLEANER	41	SSSFDHSQ12	22	SSSFHWSPL	10
SSGWCH11	39	SSSFDHSQD6	21	SSSFSD1	34
SSGWCH11E	39	SSSFDHSQD8	21	SSSFSD12	34
SSGWCH112	39	SSSFDHXD12	21	SSSFSD13	34
SSGWCH112E	39	SSSFDHXD18	21	SSSFSD2	36
SSGWCH12	39	SSSFDHXD24	21	SSSFSOG90	17
SSGWCH12E	39	SSSFDK1	25	SSSFSOG180	17
SSGWCHSEAL1	40	SSSFDK2	25	SSSFSOGADJ	17
SSGWCHSEAL2	40	SSSFDK3	25	SSSFSOGWL	17
SSGWCHSEAL3	40	SSSFDKSQ	25	SSSFSOGWR	17
SSSFCH101	39	SSSFDTRND	26	SSSFSS1	29
SSSFCH101E	39	SSSFDTSQR	26	SSSFSS2	29
SSSFCH102	39	SSSFGC90S	16	SSSFSS3	29
SSSFCH103	37	SSSFGC135S	16	SSSFSS4	29
SSSFCH103D	37	SSSFGC180S	15	SSSFSS5	29
SSSFCH103E	37	SSSFGCI90	16	SSSFSS6	30
SSSFCH103F	37	SSSFGCW1S	15	SSSFSS7	30
SSSFCH103G	37	SSSFGCW2S	15	SSSFSS8	30
SSSFCHSET1	40	SSSFH90	5	SSSFSS9	30
SSSFCHSET2	40	SSSFH90L	10	SSSFSSA	30
SSSFCHSET3	40	SSSFH135	5	SSSFSSB	30
SSSFCHSET4	40	SSSFH135L	9	SSSFTB12M	24
SSSFCHSET5	40	SSSFH180	5	SSSFTB12R	24
SSSFDHD6	21	SSSFH180L	9	SSSFTB12S	24
SSSFDHD8	21	SSSFHC90	7	SSSFTB18M	24
SSSFDHD12	21	SSSFHC135	7	SSSFTB18R	24
SSSFDHD18	21	SSSFHC180	7	SSSFTB18S	24
SSSFDHD24	21	SSSFHCW	7	SSSFTB24M	24
SSSFDHDM6	21	SSSFHFB180	12	SSSFTB24R	24
SSSFDHDM8	21	SSSFHTB	11, 37	SSSFTB24S	24
SSSFDHDM12	21	SSSFHTBV	37	SSSFTB6X18	23
SSSFDHDM18	21	SSSFHW	5	SSSFTB8X18	23
SSSFDHDM24	21	SSSFHWH	6	SSSFTBMT	23
SSSFDHL8	22	SSSFHWL	9	SSSFTBSQ	23
SSSFDHL12	22	SSSFHWOF5	6		
SSSFDHL18	22	SSSFHWOFSL	10		

Please note that great care and effort was put forth in the production of this catalogue. We apologize in advance for any inconvenience caused by any items or details not displayed correctly. Items may change or be discontinued, and new items may be added without notice. This is the most current information to date at the time of the printing of this catalogue.

For the latest updates, please refer to our website: euroeac.com.



TORONTO

127A, Aviva Park Drive,
Woodbridge, Ontario,
Canada L4L 9C1
T. 905 265.1093
TF. 800 465.7143

MONTREAL

9015 Champ D'eau,
Montreal, Quebec,
Canada H1P 3M3
T. 514 325.7977
TF. 866 574.7979

CALGARY

4100-106th Ave. SE,
Bay Door #24,
Calgary, Alberta,
Canada T2C 5B6
TF. 800 465.7143

euroeac.com