

ADJUSTABLE STANDOFFS ROUND

TILT-LOCK™ MULTI-DIRECTIONAL (2205)

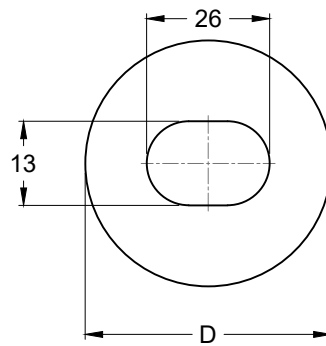

Dimensions

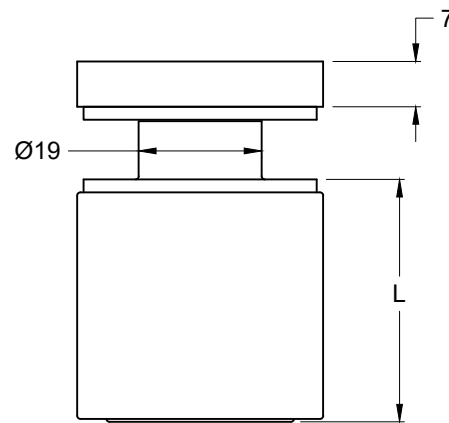

Back View

Product Code	D	L (Min)
SSAS50X35	50mm	35mm
SSAS50X45	50mm	45mm

Note: There is possibility to adjust the length of the standoffs "L" by (a maximum of) 8mm.