

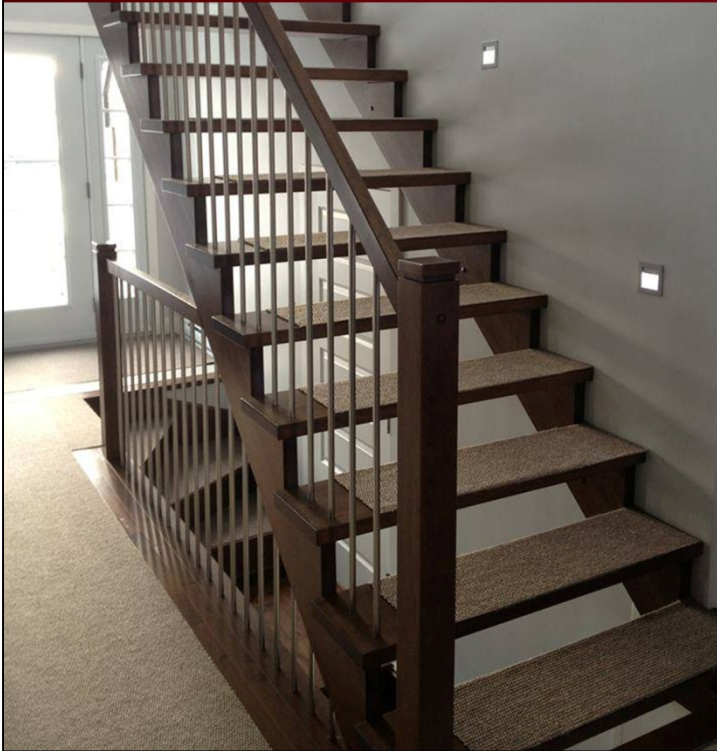

EURO FORGINGS INC.

ARCHITECTURAL COMPONENTS FOR RAILING & FENCE INDUSTRIES



Wood Handrails & Fittings Booklet

Introducing NEW selections to our Wood line

HEAD OFFICE: 127A Aviva Park Drive, Woodbridge, Ontario L4L 9C1 • Tel: 905-265-1093 • TF: 1-800-465-7143
MONTREAL OFFICE: 9015 Champ D'eau, Montreal, Quebec H1P 3M3 • Tel: 514-325-7977 • TF: 1-866-574-7979

www.euroforgings.com

PLAIN WOOD HANDRAIL

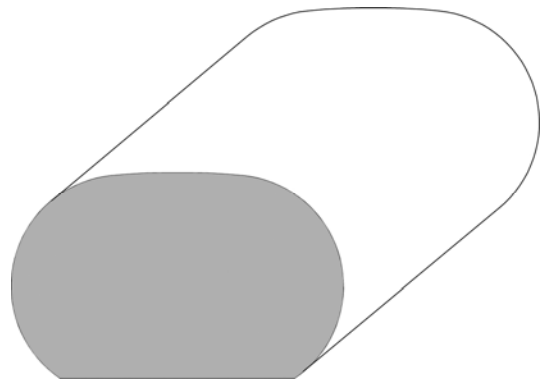
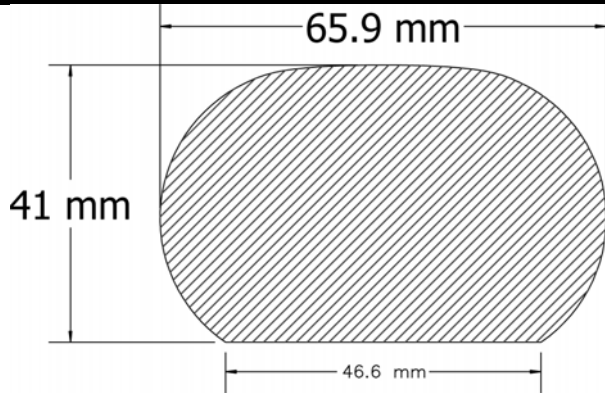

1 5/8" x 2 5/8" HANDRAIL 12 ft.

OAK WHOP258158	HARD MAPLE WHHMP258158	OAK W/ GROOVE WHOP258158G	HARD MAPLE W/ GROOVE WHHMP258158G
--------------------------	----------------------------------	-------------------------------------	---

FITTINGS

1 RISER 1/4 TURN - LEFT WHOP-D1-L	1 RISER 1/4 TURN - RIGHT WHOP-D1-R	2 RISER 1/4 TURN - LEFT WHOP-D2-L	2 RISER 1/4 TURN - RIGHT WHOP-D2-R
3" OFFSET - LEFT WHOP-O-3L	3" OFFSET - RIGHT WHOP-O-3R	6" OFFSET - LEFT WHOP-O-6L	6" OFFSET - RIGHT WHOP-O-6R
90-DEGREE CORNER BEND WHOP-C	EASEMENT WHOP-E	END TERMINAL WHOP-ET	VOLUTE WHOP-V
GOOSE NECK - LEFT WHOP-GL	GOOSE NECK - RIGHT WHOP-GR		

MODERN WOOD HANDRAIL

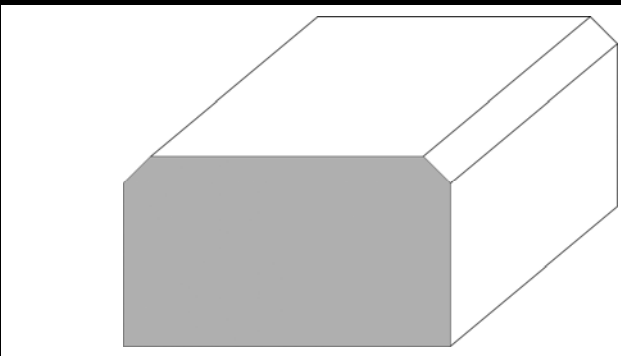
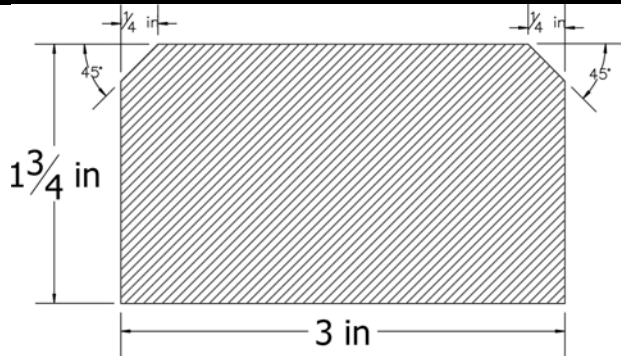

1 3/4" x 3" HANDRAIL - SQUARE/CHAMFER CORNERS 12 ft.

OAK	HARD MAPLE	OAK W/ GROOVE	HARD MAPLE W/ GROOVE
WH41343O	WH41343HM	WH41343GO	WH41343GHM

MODERN WOOD HANDRAIL

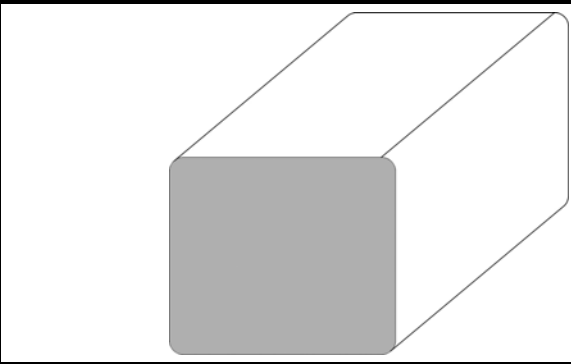
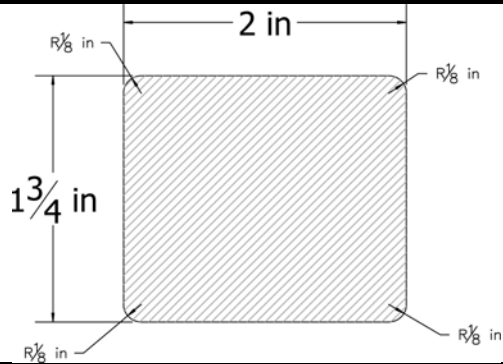

1 3/4" x 2" HANDRAIL - SQUARE 12 ft.

OAK	HARD MAPLE
WH41342O	WH41342HM

REGAL WOOD HANDRAIL

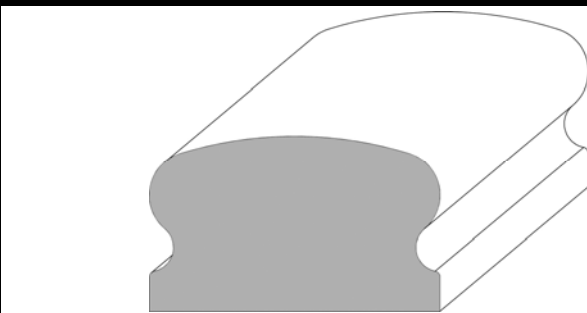
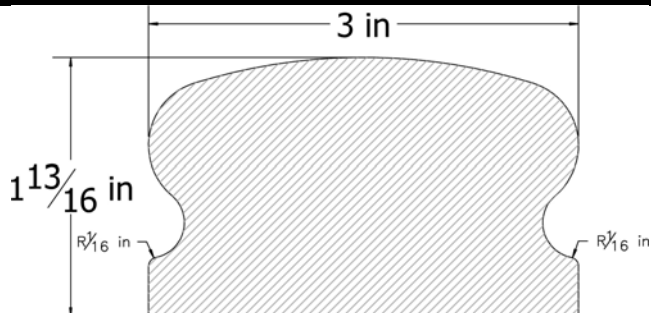

1 13/16" x 3" HANDRAIL 12 ft.

OAK	HARD MAPLE	OAK W/ GROOVE	HARD MAPLE W/ GROOVE
WH3113163O	WH3113163HM	WH3113163GO	WH3113163GHM

RAISED WOOD HANDRAIL

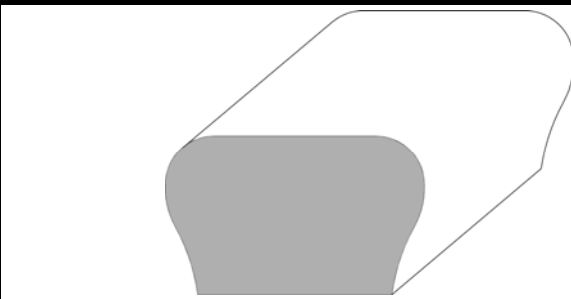
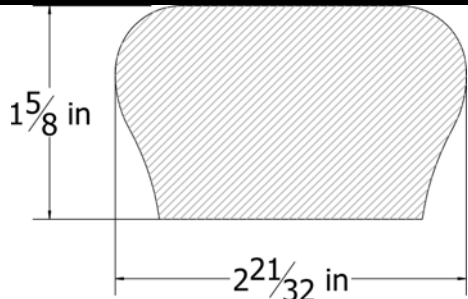

1 5/8" x 2 21/32" HANDRAIL 12 ft.

OAK	HARD MAPLE	OAK W/ GROOVE	HARD MAPLE W/ GROOVE
WH1158258O	WH1158258HM	WH1158258GO	WH1158258GHM

COLONIAL WOOD HANDRAIL

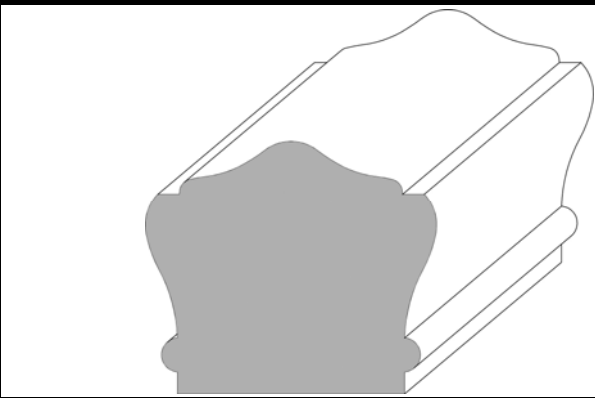
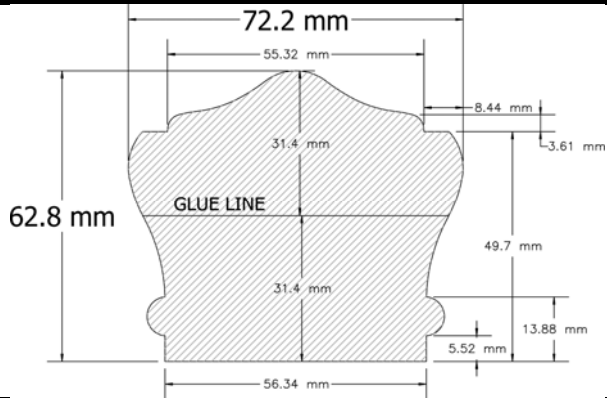

2 1/2" x 2 7/8" HANDRAIL 12 ft.

OAK	HARD MAPLE	OAK W/ GROOVE	HARD MAPLE W/ GROOVE
WHOC278212	WHHMC278212	WHOC278212G	WHHMC278212G

FITTINGS

1 RISER 1/4 TURN - LEFT	1 RISER 1/4 TURN - RIGHT	2 RISER 1/4 TURN - LEFT	2 RISER 1/4 TURN - RIGHT
WHOC-D1-L	WHOC-D1-R	WHOC-D2-L	WHOC-D2-R
3" OFFSET - LEFT	3" OFFSET - RIGHT	6" OFFSET - LEFT	6" OFFSET - RIGHT
WHOC-O-3L	WHOC-O-3R	WHOC-O-6L	WHOC-O-6R
90-DEGREE CORNER BEND	EASEMENT	END TERMINAL	VOLUTE
WHOC-C	WHOC-E	WHOC-ET	WHOC-V
GOOSE NECK - LEFT	GOOSE NECK - RIGHT		
WHOC-GL	WHOC-GR		

FINISH TRIMS

<p>1/2" x 1/2" COVE MOULD</p>		<p>3/4" x 3/4" COVE MOULD</p>	
<p>OAK</p>	<p>HARD MAPLE</p>	<p>OAK</p>	<p>HARD MAPLE</p>
<p>WCM120</p>	<p>WCM12HM</p>	<p>WCM340</p>	<p>WCM34HM</p>
<p>3/4" x 3/4" QUARTER ROUND</p>		<p>5/16" x 1 1/4" DOOR STOP</p>	
<p>OAK</p>	<p>HARD MAPLE</p>	<p>OAK</p>	<p>HARD MAPLE</p>
<p>WQR340</p>	<p>WQR34HM</p>	<p>WDS5161140</p>	<p>WDS516114HM</p>
<p>7/16" x 2 1/4" CASING</p>		<p>3/4" x 3/4" OUTSIDE CORNER</p>	
<p>OAK</p>	<p>HARD MAPLE *</p>	<p>OAK</p>	<p>HARD MAPLE</p>
<p>WCA7162140</p>	<p>WCA716214HM</p>	<p>WOC340</p>	<p>WOC34HM</p>
<p>13/16" x 1 3/4" PANEL MOULD</p>			
<p>OAK</p>	<p>HARD MAPLE *</p>		
<p>WPM13161340</p>	<p>WPM1316134HM</p>		

*These HARD MAPLE items are available by Custom Order. Contact us to inquire.

NOSING

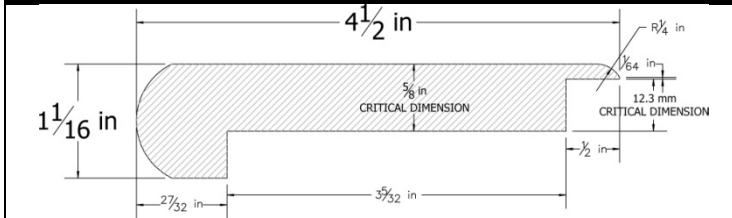

1 1/16" x 4 1/2" NOSING FOR LAMINATE

OAK

HARD MAPLE

WNL1164120

WNL116412HM

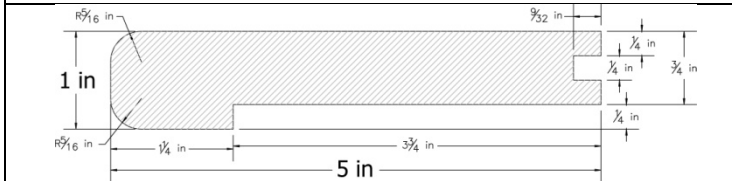

1 1/16" x 5" NOSING FOR HARDWOOD

OAK

HARD MAPLE

WNH11650

WNH1165HM

JOINTERS

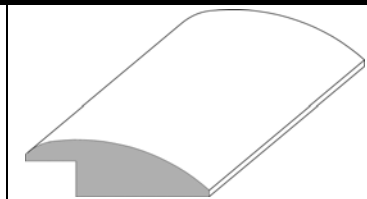
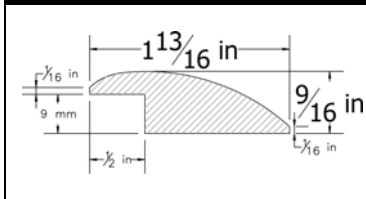

9/16" x 1 13/16" REDUCER - STANDARD

OAK

HARD MAPLE *

WR916113160

WR91611316HM

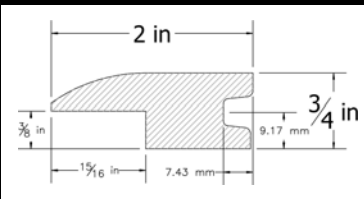

3/4" x 2" REDUCER - CARPET

OAK

HARD MAPLE *

WRC3420

WRC342HM

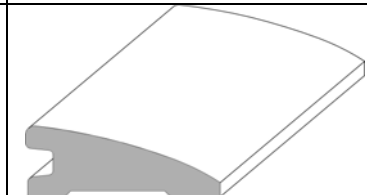
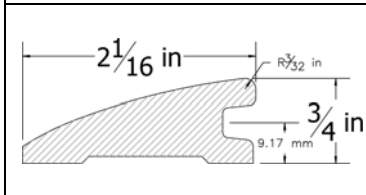

3/4" x 2 1/16" REDUCER - VINYL

OAK

HARD MAPLE *

WRV342160

WRV34216HM

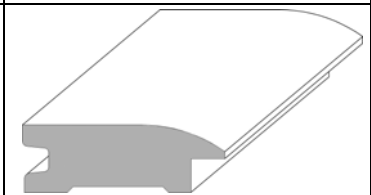
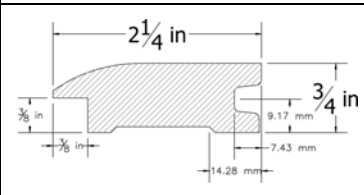

3/4" x 2 1/4" REDUCER - TILE

OAK

HARD MAPLE *

WRT342140

WRT34214HM

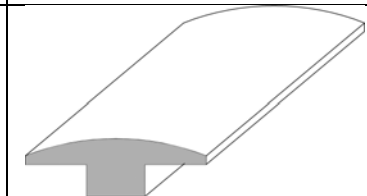
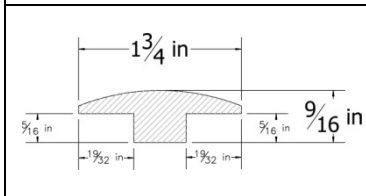

9/16" x 1 3/4" T-MOULD

OAK

HARD MAPLE *

WTM9161340

WTM916134HM

*These HARD MAPLE items are available by Custom Order. Contact us to inquire.

DOWEL

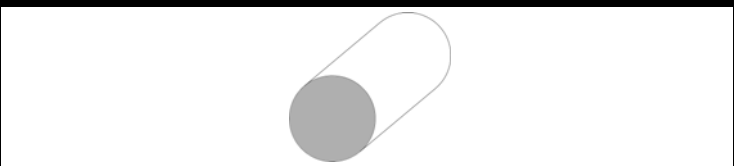
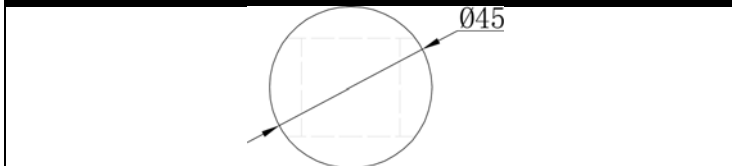

45mm DIAMETER DOWEL 12 ft.

OAK

HARD MAPLE

WHSS-O

WHSS-HM