

Front View

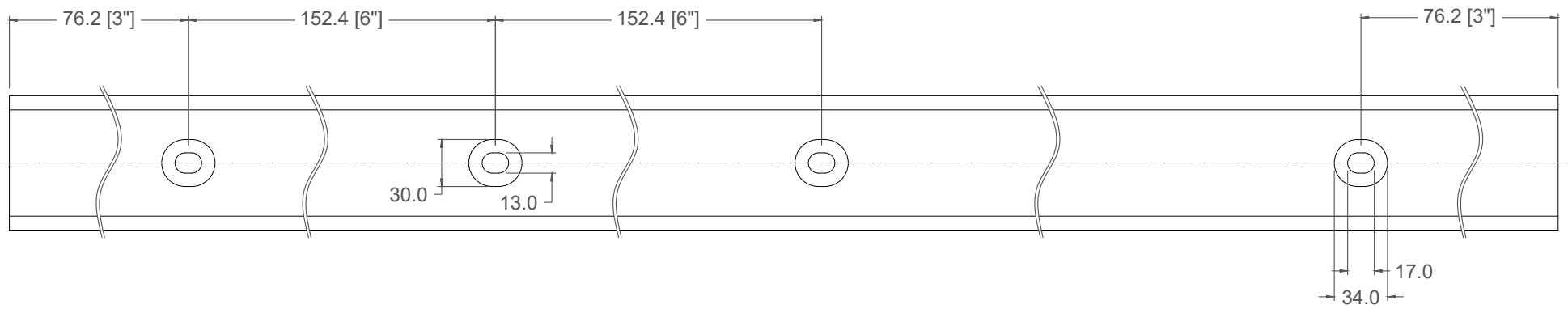

Top View

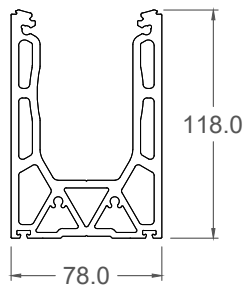
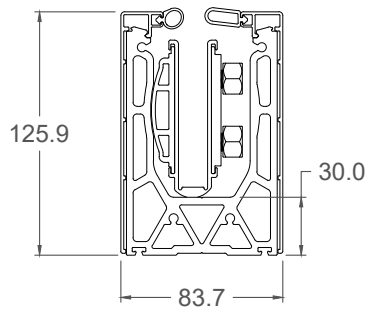

127A Aviva Park Dr.,
Woodbridge, ON, CANADA
www.euroeac.com
Toll Free: 1-800-465-7143

TITLE:
Base Shoe for 16-17.52mm Glass
Part #: SSSM4SHOE10A

DATE:	May16, 2018
SHEET:	1 of 1
REV:	01